

## Reflective Optical Sensor with Transistor Output

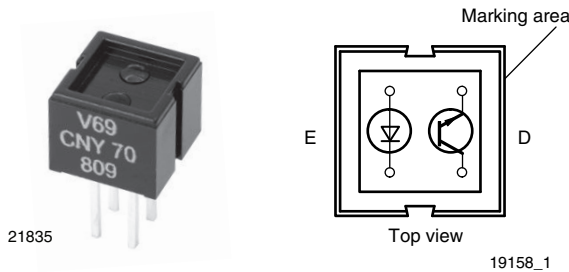

### DESCRIPTION

The CNY70 is a reflective sensor that includes an infrared emitter and phototransistor in a leaded package which blocks visible light.

### FEATURES

- Package type: leaded
- Detector type: phototransistor
- Dimensions (L x W x H in mm): 7 x 7 x 6
- Peak operating distance: < 0.5 mm
- Operating range within > 20 % relative collector current: 0 mm to 5 mm
- Typical output current under test:  $I_C = 1$  mA
- Emitter wavelength: 950 nm
- Daylight blocking filter
- Lead (Pb)-free soldering released
- Material categorization: For definitions of compliance please see [www.vishay.com/doc?99912](http://www.vishay.com/doc?99912)

**RoHS**  
COMPLIANT

### APPLICATIONS

- Optoelectronic scanning and switching devices i.e., index sensing, coded disk scanning etc. (optoelectronic encoder assemblies).

### PRODUCT SUMMARY

PART NUMBER	DISTANCE FOR MAXIMUM CTR <sub>rel</sub> (1) (mm)	DISTANCE RANGE FOR RELATIVE I <sub>out</sub> > 20 % (mm)	TYPICAL OUTPUT CURRENT UNDER TEST (2) (mA)	DAYLIGHT BLOCKING FILTER INTEGRATED
CNY70	0	0 to 5	1	Yes

#### Notes

- (1) CTR: current transference ratio,  $I_{out}/I_{in}$   
 (2) Conditions like in table basic characteristics/sensors

### ORDERING INFORMATION

ORDERING CODE	PACKAGING	VOLUME (1)	REMARKS
CNY70	Tube	MOQ: 4000 pcs, 80 pcs/tube	-

#### Note

- (1) MOQ: minimum order quantity

### ABSOLUTE MAXIMUM RATINGS (T<sub>amb</sub> = 25 °C, unless otherwise specified)

PARAMETER	TEST CONDITION	SYMBOL	VALUE	UNIT
<b>COUPLER</b>				
Total power dissipation	T <sub>amb</sub> ≤ 25 °C	P <sub>tot</sub>	200	mW
Ambient temperature range		T <sub>amb</sub>	- 40 to + 85	°C
Storage temperature range		T <sub>stg</sub>	- 40 to + 100	°C
Soldering temperature	Distance to case 2 mm, t ≤ 5 s	T <sub>sd</sub>	260	°C
<b>INPUT (EMITTER)</b>				
Reverse voltage		V <sub>R</sub>	5	V
Forward current		I <sub>F</sub>	50	mA
Forward surge current	t <sub>p</sub> ≤ 10 μs	I <sub>FSM</sub>	3	A
Power dissipation	T <sub>amb</sub> ≤ 25 °C	P <sub>V</sub>	100	mW
Junction temperature		T <sub>j</sub>	100	°C



ABSOLUTE MAXIMUM RATINGS ( $T_{amb} = 25\text{ }^{\circ}\text{C}$ , unless otherwise specified)				
PARAMETER	TEST CONDITION	SYMBOL	VALUE	UNIT
<b>OUTPUT (DETECTOR)</b>				
Collector emitter voltage		$V_{CEO}$	32	V
Emitter collector voltage		$V_{ECO}$	7	V
Collector current		$I_C$	50	mA
Power dissipation	$T_{amb} \leq 25\text{ }^{\circ}\text{C}$	$P_V$	100	mW
Junction temperature		$T_j$	100	$^{\circ}\text{C}$

**ABSOLUTE MAXIMUM RATINGS**

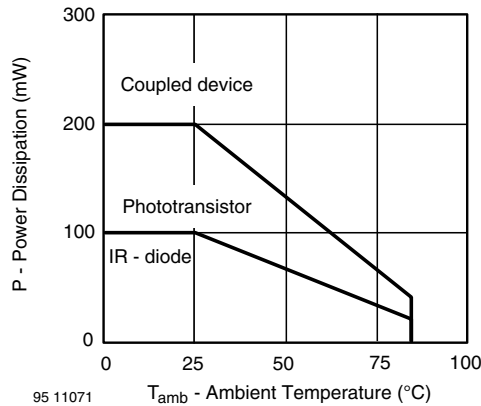

Fig. 1 - Power Dissipation vs. Ambient Temperature

BASIC CHARACTERISTICS ( $T_{amb} = 25\text{ }^{\circ}\text{C}$ , unless otherwise specified)						
PARAMETER	TEST CONDITION	SYMBOL	MIN.	TYP.	MAX.	UNIT
<b>COUPLER</b>						
Collector current	$V_{CE} = 5\text{ V}$ , $I_F = 20\text{ mA}$ , $d = 0.3\text{ mm}$ (figure 1)	$I_C^{(2)}$	0.3	1.0		mA
Cross talk current	$V_{CE} = 5\text{ V}$ , $I_F = 20\text{ mA}$ , (figure 2)	$I_{CX}^{(3)}$			600	nA
Collector emitter saturation voltage	$I_F = 20\text{ mA}$ , $I_C = 0.1\text{ mA}$ , $d = 0.3\text{ mm}$ (figure 1)	$V_{CEsat}^{(2)}$			0.3	V
<b>INPUT (EMITTER)</b>						
Forward voltage	$I_F = 50\text{ mA}$	$V_F$		1.25	1.6	V
Radiant intensity	$I_F = 50\text{ mA}$ , $t_p = 20\text{ ms}$	$I_e$			7.5	mW/sr
Peak wavelength	$I_F = 100\text{ mA}$	$\lambda_P$	940			nm
Virtual source diameter	Method: 63 % encircled energy	$d$		1.2		mm
<b>OUTPUT (DETECTOR)</b>						
Collector emitter voltage	$I_C = 1\text{ mA}$	$V_{CEO}$	32			V
Emitter collector voltage	$I_E = 100\text{ }\mu\text{A}$	$V_{ECO}$	5			V
Collector dark current	$V_{CE} = 20\text{ V}$ , $I_F = 0\text{ A}$ , $E = 0\text{ lx}$	$I_{CEO}$			200	nA

**Notes**

- (1) Measured with the "Kodak neutral test card", white side with 90 % diffuse reflectance
- (2) Measured without reflecting medium

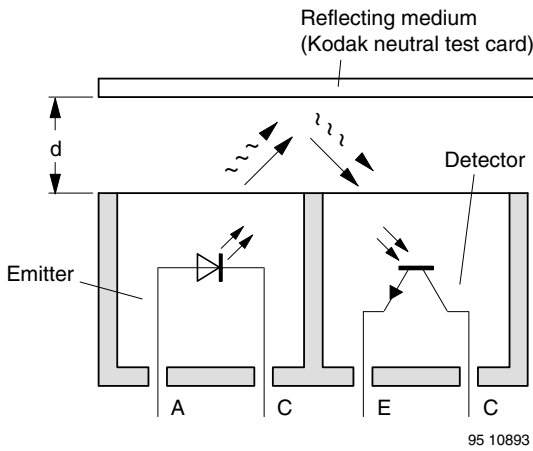

Fig. 2 - Test Condition

**BASIC CHARACTERISTICS** ( $T_{amb} = 25\text{ }^{\circ}\text{C}$ , unless otherwise specified)

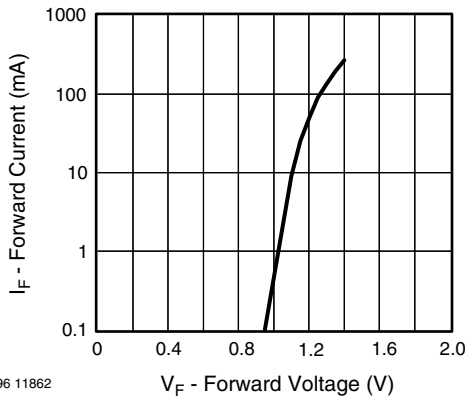

Fig. 3 - Forward Current vs. Forward Voltage

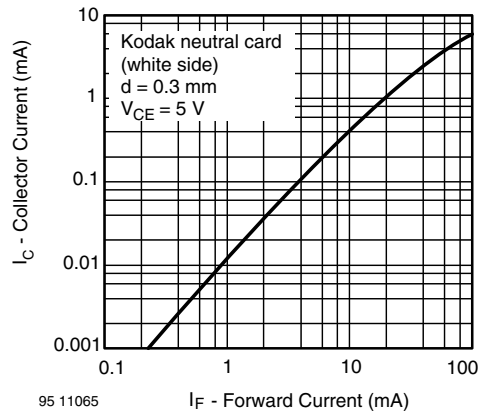

Fig. 5 - Collector Current vs. Forward Current

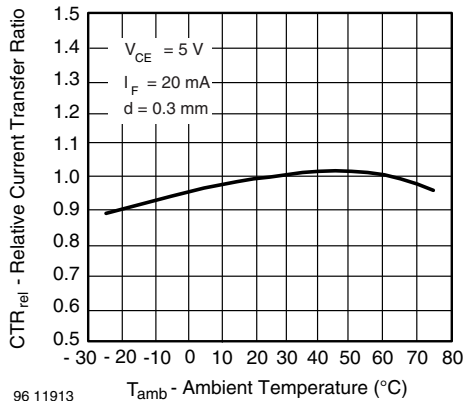

Fig. 4 - Relative Current Transfer Ratio vs. Ambient Temperature

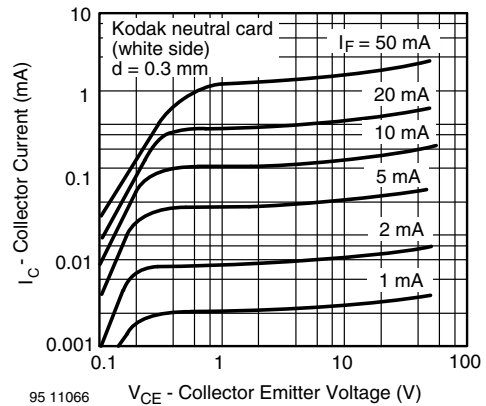

Fig. 6 - Collector Current vs. Collector Emitter Voltage

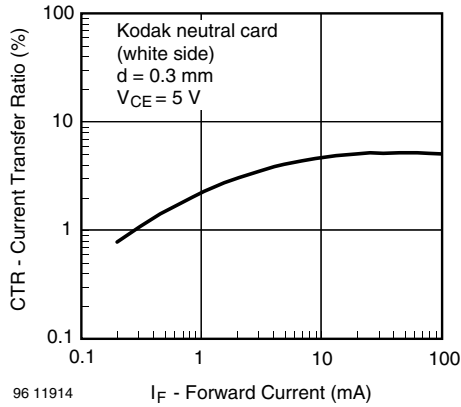

Fig. 7 - Current Transfer Ratio vs. Forward Current

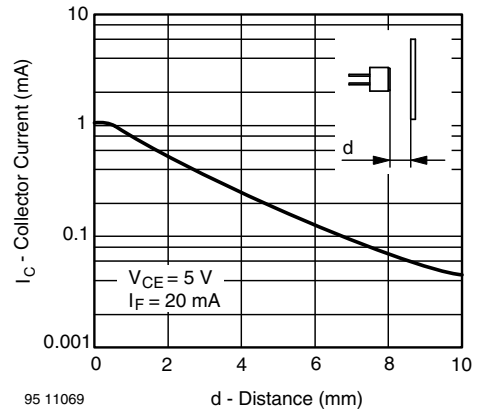

Fig. 9 - Collector Current vs. Distance

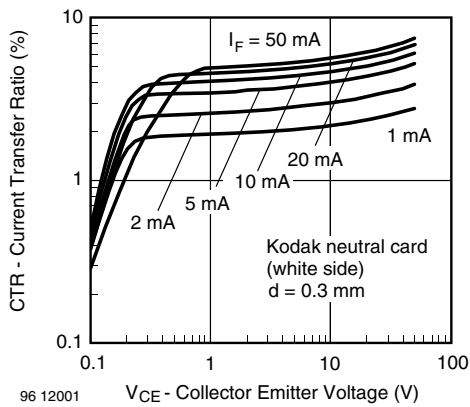

Fig. 8 - Current Transfer Ratio vs. Collector Emitter Voltage

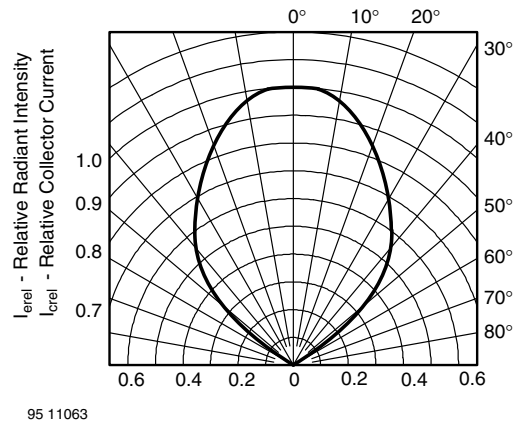

Fig. 10 - Relative Radiant Intensity/Collector Current vs. Angular Displacement

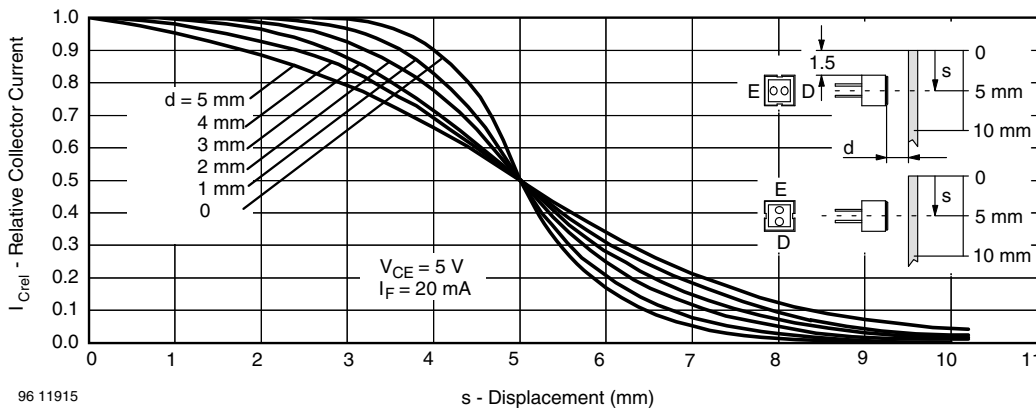
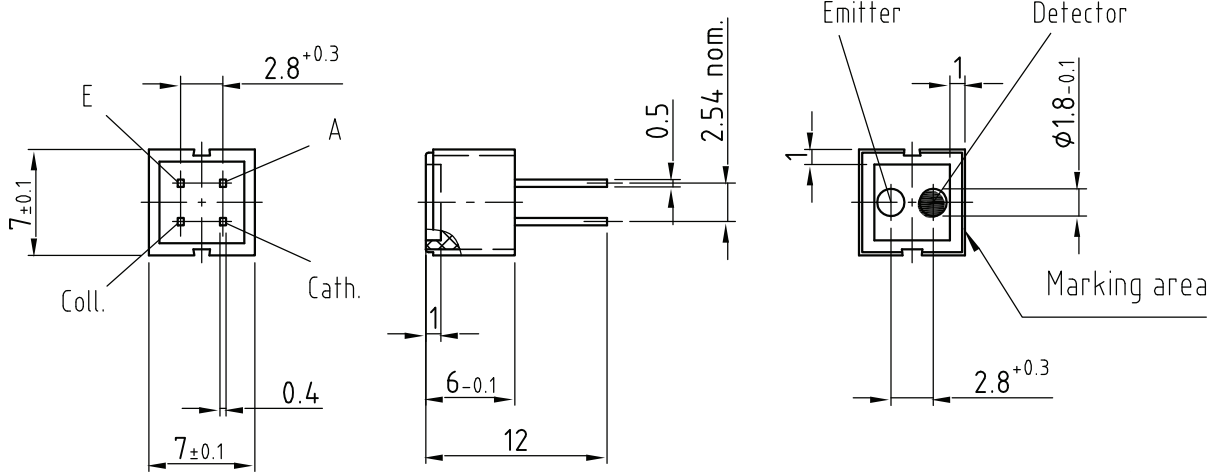
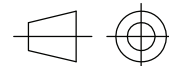

Fig. 11 - Relative Collector Current vs. Displacement

**PACKAGE DIMENSIONS** in millimeters



weight: ca. 0.70g



technical drawings according to DIN specifications

Drawing-No.: 6.544-5062.01-4

Issue: 6; 03.05.06

95 11345

**TUBE DIMENSIONS** in millimeters

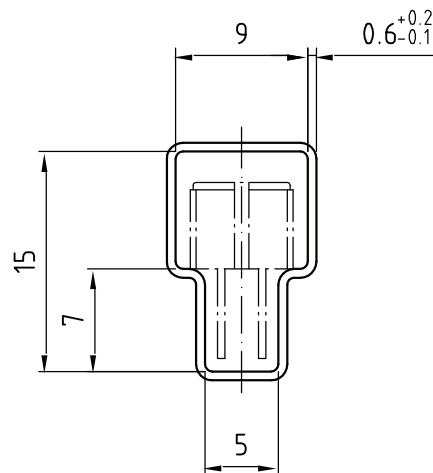

With rubber stopper

Tolerance:  $\pm 0.5$ mm

Length:  $575 \pm 1$ mm

Drawing-No.: 9.700-5097.01-4

Issue: 1; 25.02.00

20291



## **Disclaimer**

ALL PRODUCT, PRODUCT SPECIFICATIONS AND DATA ARE SUBJECT TO CHANGE WITHOUT NOTICE TO IMPROVE RELIABILITY, FUNCTION OR DESIGN OR OTHERWISE.

Vishay Intertechnology, Inc., its affiliates, agents, and employees, and all persons acting on its or their behalf (collectively, "Vishay"), disclaim any and all liability for any errors, inaccuracies or incompleteness contained in any datasheet or in any other disclosure relating to any product.

Vishay makes no warranty, representation or guarantee regarding the suitability of the products for any particular purpose or the continuing production of any product. To the maximum extent permitted by applicable law, Vishay disclaims (i) any and all liability arising out of the application or use of any product, (ii) any and all liability, including without limitation special, consequential or incidental damages, and (iii) any and all implied warranties, including warranties of fitness for particular purpose, non-infringement and merchantability.

Statements regarding the suitability of products for certain types of applications are based on Vishay's knowledge of typical requirements that are often placed on Vishay products in generic applications. Such statements are not binding statements about the suitability of products for a particular application. It is the customer's responsibility to validate that a particular product with the properties described in the product specification is suitable for use in a particular application. Parameters provided in datasheets and / or specifications may vary in different applications and performance may vary over time. All operating parameters, including typical parameters, must be validated for each customer application by the customer's technical experts. Product specifications do not expand or otherwise modify Vishay's terms and conditions of purchase, including but not limited to the warranty expressed therein.

Hyperlinks included in this datasheet may direct users to third-party websites. These links are provided as a convenience and for informational purposes only. Inclusion of these hyperlinks does not constitute an endorsement or an approval by Vishay of any of the products, services or opinions of the corporation, organization or individual associated with the third-party website. Vishay disclaims any and all liability and bears no responsibility for the accuracy, legality or content of the third-party website or for that of subsequent links.

Vishay products are not designed for use in life-saving or life-sustaining applications or any application in which the failure of the Vishay product could result in personal injury or death unless specifically qualified in writing by Vishay. Customers using or selling Vishay products not expressly indicated for use in such applications do so at their own risk. Please contact authorized Vishay personnel to obtain written terms and conditions regarding products designed for such applications.

No license, express or implied, by estoppel or otherwise, to any intellectual property rights is granted by this document or by any conduct of Vishay. Product names and markings noted herein may be trademarks of their respective owners.