



DC COMPONENTS CO., LTD.

RECTIFIER SPECIALISTS

**P4KE6.8
THRU
P4KE440CA**

TECHNICAL SPECIFICATIONS OF TRANSIENT VOLTAGE SUPPRESSOR
VOLTAGE RANGE - 6.8 to 440 Volts **PEAK PULSE POWER - 400 Watts**

FEATURES

- * Glass passivated junction
- * 400 Watts Peak Pulse Power capability on 10/1000 us waveform
- * Excellent clamping capability
- * Low zener impedance
- * Fast response time

MECHANICAL DATA

- * Case: Molded plastic
- * Epoxy: UL 94V-0 rate flame retardant
- * Lead: MIL-STD-202E, Method 208 guaranteed
- * Polarity: Color band denotes positive end (cathode) except bidirectional types
- * Mounting position: Any
- * Weight: 0.3 gram

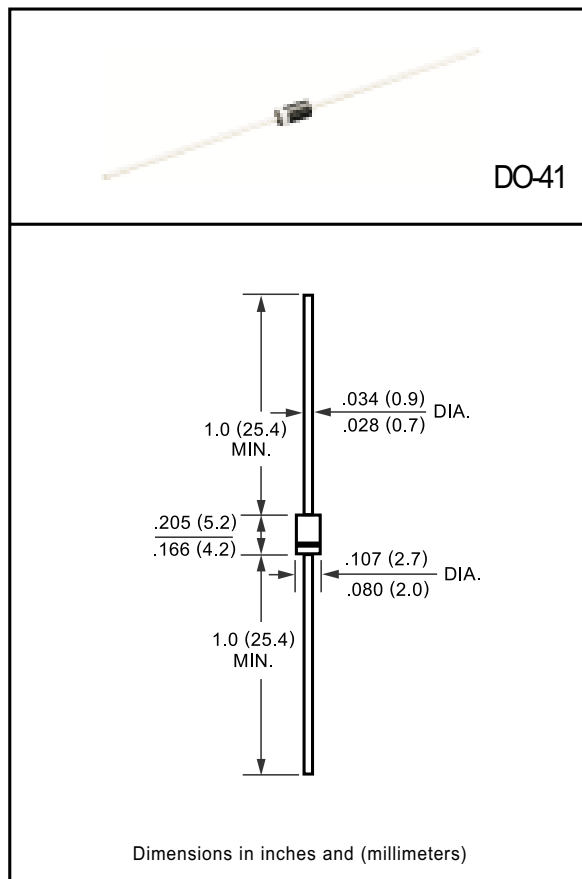

MAXIMUM RATINGS AND ELECTRICAL CHARACTERISTICS

Ratings at 25 °C ambient temperature unless otherwise specified.
 Single phase, half wave, 60 Hz, resistive or inductive load,
 For capacitive load, derate current by 20%.

DEVICES FOR BIPOLAR APPLICATIONS

For Bidirectional use C or CA suffix (e.g. P4KE6.8C, P4KE440CA)
 Electrical characteristics apply in both directions

	SYMBOL	VALUE	UNITS
Peak Pulse Power Dissipation on 10/1000 us waveform (Note1,FIG.1)	PPPM	Minimum 400	Watts
Steady State Power Dissipation at T _L = 75°C Lead Lengths .375" (9.5 mm) (Note 2)	P _{M(AV)}	1.0	Watts
Peak Forward Surge Current, 8.3ms single half sine-wave superimposed on rated load(JEDEC Method) (Note 3)	I _{FSM}	40	Amps
Maximum Instantaneous Forward Voltage at 50A for Unidirectional Only (Note 4)	V _F	3.5/6.5	Volts
Operating and Storage Temperature Range	T _J , T _{STG}	-65 to + 175	°C

- NOTES : 1. Non-repetitive current pulse, per Fig.3 and derated above T_A = 25°C per Fig.2.
 2. Mounted on Copper Leaf area of 1.6 X 1.6" (40 X 40mm) per Fig. 5
 3. 8.3ms single half sine-wave or equivalent square wave, duty cycle = 4 pulses per minute maximum.
 4. V_F = 3.5V max. for devices of V(BR) ≤ 200V and V_F = 6.5 V max. for devices of V(BR) > 200V.

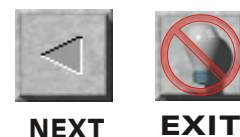

RATING AND CHARACTERISTIC CURVES (P4KE6.8 THRU P4KE440CA)

FIG. 1 - PEAK PULSE POWER RATING CURVE

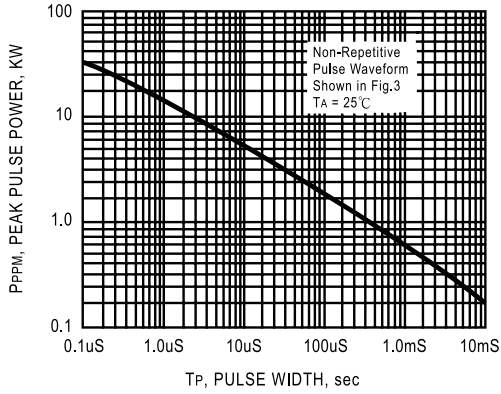

FIG. 2 - PULSE DERATING CURVE

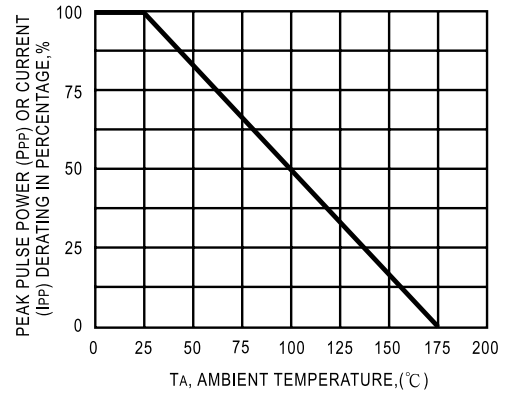

FIG. 3 - PULSE WAVEFORM

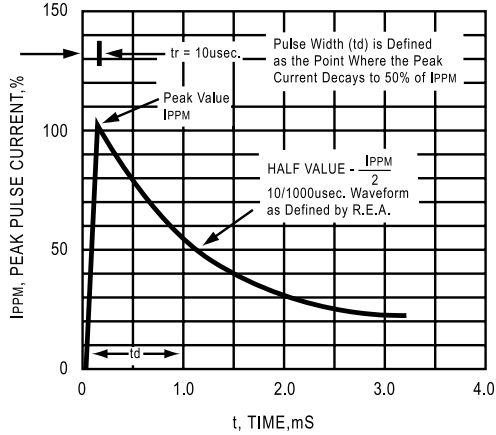

FIG. 4 - TYPICAL JUNCTION CAPACITANCE

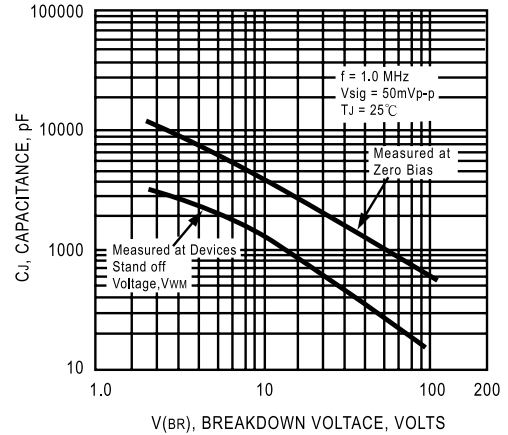

FIG. 5 - STEADY STATE POWER DERATING CURVE

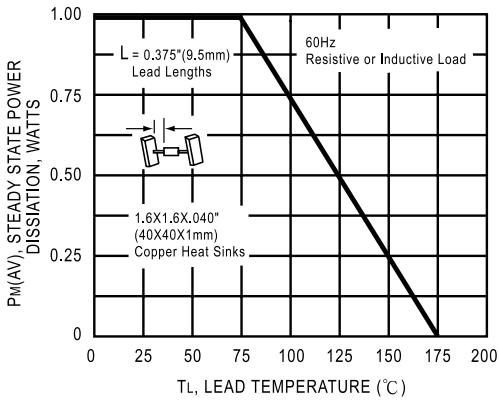

FIG. 6 - MAXIMUM NON-REPETITIVE FORWARD SURGE CURRENT UNIDIRECTIONAL

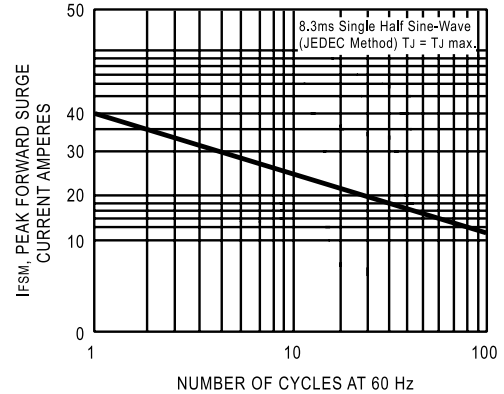
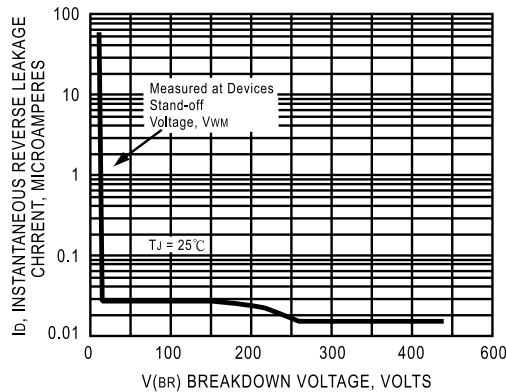

FIG. 7 - TYPICAL REVERSE LEAKAGE CHARACTERISTICS



DC COMPONENTS CO., LTD.



NEXT

BACK

EXIT

P4KE (400W) SERIES TRANSIENT VOLTAGE SUPPRESSORS

TYPE	Breakdown Voltage		@IT (mA)	Reverse Stand off Voltage VWM (Volts)	Maximum Reverse Leakage at VWM ID(uA)	Maximum Peak Pulse Current IPPM (Amps)	Maximum Clamping Voltage at IPPM Vc (Volts)
	VBR (Volts)						
	MIN.	MAX.					
P4KE6.8	6.12	7.48	10	5.50	1000	38	10.8
P4KE6.8A	6.45	7.14	10	5.80	1000	40	10.5
P4KE7.5	6.75	8.25	10	6.05	500	35	11.7
P4KE7.5A	7.13	7.88	10	6.40	500	37	11.3
P4KE8.2	7.38	9.02	10	6.63	200	33	12.5
P4KE8.2A	7.79	8.61	10	7.02	200	34	12.1
P4KE9.1	8.19	10.0	1.0	7.37	50	30	13.8
P4KE9.1A	8.69	9.55	1.0	7.78	50	31	13.4
P4KE10	9.00	11.0	1.0	8.10	10	28	15.0
P4KE10A	9.50	10.5	1.0	8.55	10	29	14.5
P4KE11	9.90	12.1	1.0	8.92	5.0	26	16.2
P4KE11A	10.5	11.6	1.0	9.40	5.0	27	15.6
P4KE12	10.8	13.2	1.0	9.72	5.0	24	17.3
P4KE12A	11.4	12.6	1.0	10.2	5.0	25	16.7
P4KE13	11.7	14.3	1.0	10.5	5.0	22	19.0
P4KE13A	12.4	13.7	1.0	11.1	5.0	23	18.2
P4KE15	13.5	16.5	1.0	12.1	5.0	19	22.0
P4KE15A	14.3	15.8	1.0	12.8	5.0	20	21.2
P4KE16	14.4	17.6	1.0	12.9	5.0	17.8	23.5
P4KE16A	15.2	16.8	1.0	13.6	5.0	18.6	22.5
P4KE18	16.2	19.8	1.0	14.5	5.0	16	26.5
P4KE18A	17.1	18.9	1.0	15.3	5.0	16.5	25.2
P4KE20	18.0	22.0	1.0	16.2	5.0	14	29.1
P4KE20A	19.0	21.0	1.0	17.1	5.0	15	27.7
P4KE22	19.8	24.2	1.0	17.8	5.0	13	31.9
P4KE22A	20.9	23.1	1.0	18.8	5.0	13.7	30.6
P4KE24	21.6	26.4	1.0	19.4	5.0	12	34.7
P4KE24A	22.8	25.2	1.0	20.5	5.0	12.6	33.2
P4KE27	24.3	29.7	1.0	21.8	5.0	10.7	39.1
P4KE27A	25.7	28.4	1.0	23.1	5.0	11.0	37.5
P4KE30	27.0	33.0	1.0	24.3	5.0	9.6	43.5
P4KE30A	28.5	31.5	1.0	25.6	5.0	10	41.4
P4KE33	29.7	36.3	1.0	26.8	5.0	8.8	47.7
P4KE33A	31.4	34.7	1.0	28.2	5.0	9	45.7
P4KE36	32.4	39.6	1.0	29.1	5.0	8	52.0
P4KE36A	34.2	37.8	1.0	30.8	5.0	8.4	49.9
P4KE39	35.1	42.9	1.0	31.6	5.0	7.4	56.4
P4KE39A	37.1	41.0	1.0	33.3	5.0	7.7	53.9
P4KE43	38.7	47.3	1.0	34.8	5.0	6.7	61.9
P4KE43A	40.9	45.2	1.0	36.8	5.0	7.0	59.3
P4KE47	42.3	51.7	1.0	38.1	5.0	6.2	67.8
P4KE47A	44.7	49.4	1.0	40.2	5.0	6.4	64.8
P4KE51	45.9	56.1	1.0	41.3	5.0	5.7	73.5
P4KE51A	48.5	53.6	1.0	43.6	5.0	6.0	70.1
P4KE56	50.4	61.6	1.0	45.4	5.0	5.2	80.5
P4KE56A	53.2	58.8	1.0	47.8	5.0	5.4	77.0



DC COMPONENTS CO., LTD.

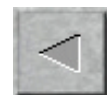

NEXT

BACK

EXIT

P4KE (400W) SERIES TRANSIENT VOLTAGE SUPPRESSORS

TYPE	Breakdown Voltage		@IT (mA)	Reverse Stand off Voltage VWM (Volts)	Maximum Reverse Leakage at VWM ID(uA)	Maximum Peak Pulse Current IPPM (Amps)	Maximum Clamping Voltage at IPPM Vc (Volts)
	VBR (Volts)						
	MIN.	MAX.					
P4KE62	55.8	68.2	1.0	50.2	5.0	4.7	89.0
P4KE62A	58.9	65.1	1.0	53.0	5.0	5.0	85.0
P4KE68	61.2	74.8	1.0	55.1	5.0	4.2	98.0
P4KE68A	64.6	71.4	1.0	58.1	5.0	4.5	92.0
P4KE75	67.5	82.5	1.0	60.7	5.0	3.8	108
P4KE75A	71.3	78.8	1.0	64.1	5.0	4.0	103
P4KE82	73.8	90.2	1.0	66.4	5.0	3.5	118
P4KE82A	77.9	86.1	1.0	70.1	5.0	3.7	113
P4KE91	81.9	100	1.0	73.7	5.0	3.2	131
P4KE91A	86.5	95.5	1.0	77.8	5.0	3.3	125
P4KE100	90.0	110	1.0	81.0	5.0	2.9	144
P4KE100A	95.0	105	1.0	85.5	5.0	3.0	137
P4KE110	99.0	121	1.0	89.2	5.0	2.6	158
P4KE110A	105	116	1.0	94.0	5.0	2.7	152
P4KE120	108	132	1.0	97.2	5.0	2.4	173
P4KE120A	114	126	1.0	102	5.0	2.5	165
P4KE130	117	143	1.0	105	5.0	2.2	187
P4KE130A	124	137	1.0	111	5.0	2.3	179
P4KE150	135	165	1.0	121	5.0	1.9	215
P4KE150A	143	158	1.0	128	5.0	2.0	207
P4KE160	144	176	1.0	130	5.0	1.8	230
P4KE160A	152	168	1.0	136	5.0	1.9	219
P4KE170	153	187	1.0	138	5.0	1.7	244
P4KE170A	162	179	1.0	145	5.0	1.8	234
P4KE180	162	198	1.0	146	5.0	1.6	258
P4KE180A	171	189	1.0	154	5.0	1.7	246
P4KE200	180	220	1.0	162	5.0	1.4	287
P4KE200A	190	210	1.0	171	5.0	1.5	274
P4KE220	198	242	1.0	175	5.0	1.2	344
P4KE220A	209	231	1.0	185	5.0	1.3	328
P4KE250	225	275	1.0	202	5.0	1.1	360
P4KE250A	237	263	1.0	214	5.0	1.2	344
P4KE300	270	330	1.0	243	5.0	0.97	430
P4KE300A	285	315	1.0	256	5.0	1.00	414
P4KE350	315	385	1.0	284	5.0	0.83	504
P4KE350A	332	368	1.0	300	5.0	0.87	482
P4KE400	360	440	1.0	324	5.0	0.73	574
P4KE400A	380	420	1.0	342	5.0	0.76	548
P4KE440	396	484	1.0	356	5.0	0.64	630
P4KE440A	418	462	1.0	376	5.0	0.67	600

- NOTES : 1.VBR measured after IT applied for 300Us. IT = Square Pulse Wave or equivalent.
 2.For bidirectional use C or CA suffixs for all types (ex. P4KE6.8C, P4KE440CA).
 electrical characteristics apply in both directions.
 3.For bidirectional types having VWM of 10 volts and less, the ID limit is doubled.



DC COMPONENTS CO., LTD.



NEXT



BACK



EXIT