

SB320 ... SB3100

Schottky Barrier Rectifier Diodes Schottky-Barrier-Gleichrichterdiodes

Version 2013-01-30

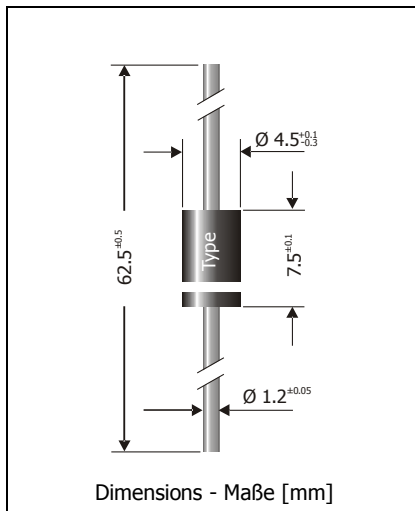

Nominal current Nennstrom	3 A
Repetitive peak reverse voltage Periodische Spitzensperrspannung	20...100 V
Plastic case Kunststoffgehäuse	~ DO-201
Weight approx. Gewicht ca.	1 g
Plastic material has UL classification 94V-0 Gehäusematerial UL94V-0 klassifiziert	
Standard packaging taped in ammo pack Standard Lieferform gegurtet in Ammo-Pack	



Maximum ratings and Characteristics

Grenz- und Kennwerte

Type Typ	Repetitive peak reverse voltage Periodische Spitzensperrspannung V_{RRM} [V]	Surge peak reverse voltage Stoßspitzensperrspannung V_{RSM} [V]	Forward voltage Durchlass-Spannung V_F [V] ¹⁾
SB320	20	20	< 0.49
SB330	30	30	< 0.49
SB340	40	40	< 0.49
SB350	50	50	< 0.68
SB360	60	60	< 0.68
SB390	90	90	< 0.78
SB3100	100	100	< 0.78

Max. average forward rectified current, R-load Dauergrenzstrom in Einwegschaltung mit R-Last	$T_A = 75^\circ\text{C}$	I_{FAV}	3 A ²⁾
Repetitive peak forward current Periodischer Spitzenstrom	$f > 15\text{ Hz}$	I_{FRM}	15 A ²⁾
Peak forward surge current, 50/60 Hz half sine-wave Stoßstrom für eine 50/60 Hz Sinus-Halbwellen	$T_A = 25^\circ\text{C}$	I_{FSM}	87/100 A
Rating for fusing, $t < 10\text{ ms}$ Grenzlastintegral, $t < 10\text{ ms}$	$T_A = 25^\circ\text{C}$	i^2t	110 A ² s
Junction temperature – Sperrschichttemperatur Storage temperature – Lagerungstemperatur		T_j T_s	-50...+150°C -50...+175°C

1 $I_F = 3\text{ A}, T_j = 25^\circ\text{C}$

2 Valid, if leads are kept at ambient temperature at a distance of 10 mm from case
Gültig, wenn die Anschlussdrähte in 10 mm Abstand vom Gehäuse auf Umgebungstemperatur gehalten werden

Characteristics
Kennwerte

Leakage current Sperrstrom	$T_j = 25^\circ\text{C}$	SB320...360 SB390...3100	$V_R = V_{RRM}$ $V_R = V_{RRM}$	I_R I_R	< 0.5 mA < 0.6 mA
Thermal resistance junction to ambient air Wärmewiderstand Sperrschicht – umgebende Luft				R_{thA}	< 25 K/W ¹⁾
Thermal resistance junction to leads Wärmewiderstand Sperrschicht – Anschlussdraht				R_{thL}	< 8 K/W

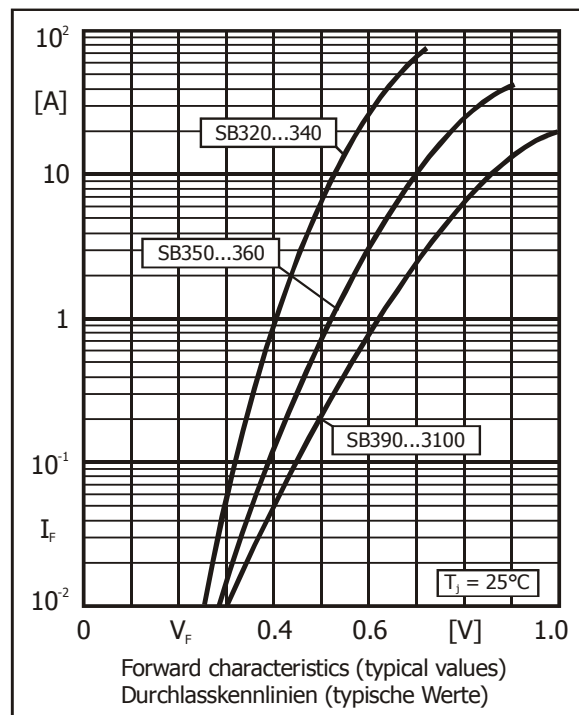
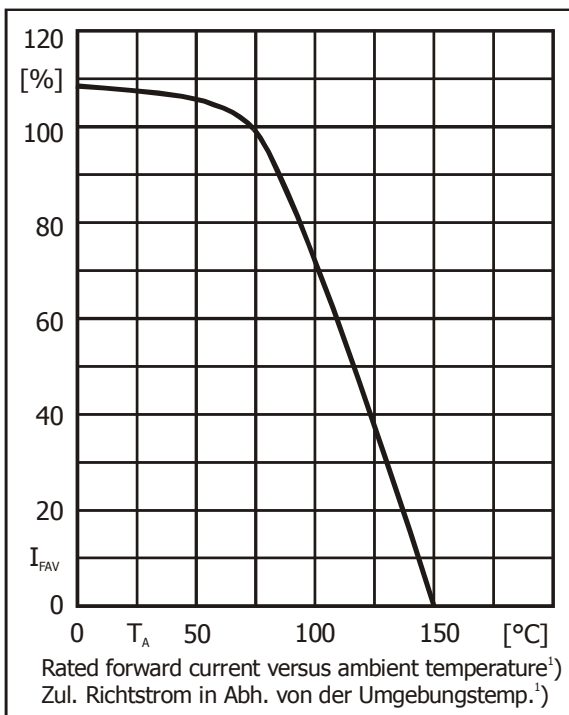

¹ Valid, if leads are kept at ambient temperature at a distance of 10 mm from case
Gültig, wenn die Anschlussdrähte in 10 mm Abstand vom Gehäuse auf Umgebungstemperatur gehalten werden