

E-CALL ENTERPRISE CO., LTD.



PROFESSIONAL MANUFACTURER

www.ecall-elec.com.tw



HEADQUARTER

E-CALL ENTERPRISE CO., LTD.
6FL, NO. 221, CHUNG YUNG ROAD,
NAN KANG DIST, 11573, TAIPEI, TAIWAN, R.O.C.
TEL: +886-2-2788-9688 (REP.)
FAX: +886-2-2651-1996, 2651-4606
E-MAIL: ecall@seed.net.tw
ecall@ecall-elec.com.tw



FACTORY

E-LINE ELECTRONICS SHANGHAI CO., LTD.
BUILDING NO. A, NO. 88, LANE 3509
HONG MEI SOUTH ROAD, SHANGHAI,
CHINA 201108
TEL: +86-21-34634361 (REP.)
FAX: +86-21-34634363
E-MAIL: e-line_sh@163.com

ISO9001-2008 APPROVED

SOLDERLESS
BREADBOARD

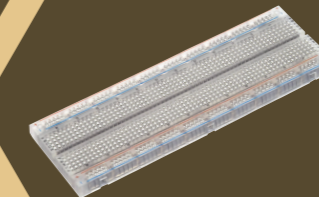

JUMPER WIRE KIT



POM PLASTIC
BREADBOARD

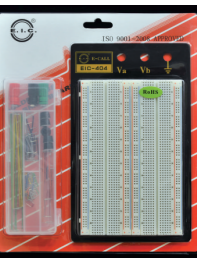

CABINET

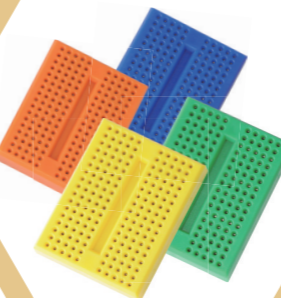

COLORFUL
BREADBOARD

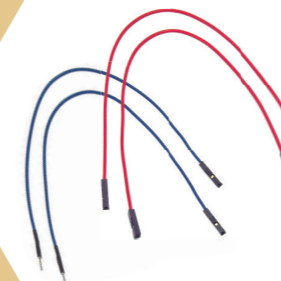

MACHINE PIN
JUMPER WIRE

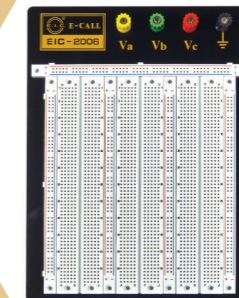

TRANSPARENT
BREADBOARD



SOLDER TAIL
BREADBOARD

Company Profile

About E-Call ...

- Established since 1985
- Registered as Exporter and Manufacturer
- Capital: NTD20,000,000-
- ISO 9001-2008 approved
- Employees: 30 persons
- Office & Manufacturing facilities: 1000m²

About E-Line...(E-Call in Shanghai)

- Established on July 17, 2001
- Capital: USD700,000-
- Employees: 150 persons at present
- Office & Manufacturing facilities: 2000m²

Main Products...

- Solderless breadboards and accessories (E.I.C. logo)
- Metal Keypad assembly
- Hi-Rel IC sockets and PGA sockets
- Wire harness and flat cable assembly

China patent certificate

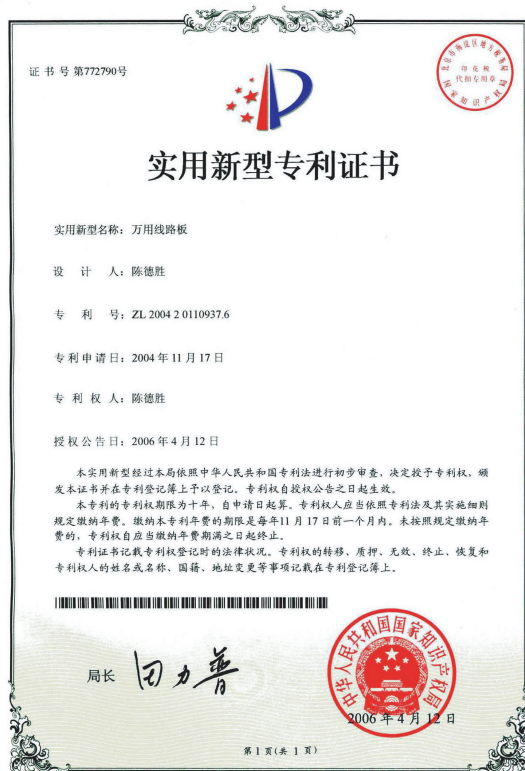

Patent No. : ZL 2004 2 0110937. 6



Patent No. : ZL 2004 3 0106004.5



Patent No. : ZL 02 3 47714. 8

SOLDERLESS BREADBOARD: ABS PLASTIC/ SQUARE HOLE

Body material : EIC Brand, ABS plastic

Surface : Colored printing

Heat distortion temperature : 84°C

Plate material : Metal

Surface : Black

RoHS Compliance

Spring clip contact : Phosphor Bronze

Finish : Nickel plated

Contact life : 50,000 times

Insertion range : 0.4~0.7mm diameter





E.I.C. blister card package

Combines additional boards for larger breadboard available

OEM & Own design is welcome

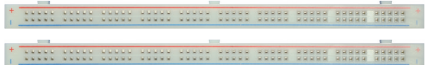
DN = Distribution strips

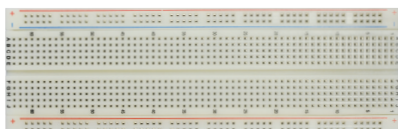
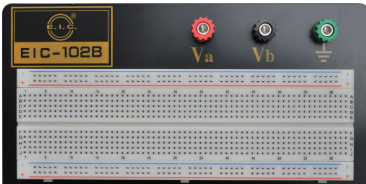
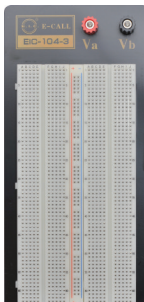
TN = Terminal strips

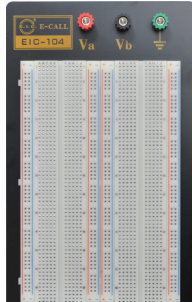
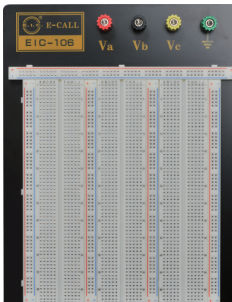
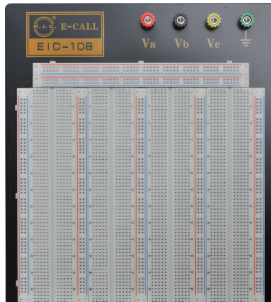
<p>EIC-DN (100 Tie-point/PC) *2PCS/SET*</p>  <p>Board:165.1*9.4*8.5mm</p>	<p>EIC-TN (630 Tie-point)</p>  <p>Board:165.1*35.5*8.5mm</p>	<p>EIC-102 (830 Tie-point)</p>  <p>Board: 165.1*54.6*8.5mm Plate: 164*52*0.3mm</p>
<p>EIC-102B</p>  <p>(830 Tie-point) 3 Binding posts, 5 Cushions Board:165.1*54.6*8.5mm Plate: 183*95*0.8mm</p>	<p>EIC-104-3</p> <p>EIC-DN*1PC EIC-TN*2PS (1360 Tie-point) 2 Binding posts 5 Cushions</p>  <p>Board: 165.1*80.8*8.5mm Plate: 215*100*0.8mm</p>	<p>EIC-104-1</p> <p>EIC-DN*3PS EIC-TN*2PS (1560 Tie-point) 3 Binding posts 5 Cushions</p>  <p>Board: 165.1*99.7*8.5mm Plate: 215*130*0.8mm</p>
<p>EIC-104</p> <p>EIC-DN*4PS EIC-TN*2PS (1660 Tie-point) 3 Binding posts 5 Cushions</p>  <p>Board: 165.1*109.3*8.5mm Plate: 215*130*0.8mm</p>	<p>EIC-106</p> <p>EIC-DN*5PS EIC-TN*3PS (2390 Tie-point) 4 Binding posts 5 Cushions</p>  <p>Board: 174.8*165.1*8.5mm Plate: 230*175*0.8mm</p>	<p>EIC-108</p> <p>EIC-DN*7PS EIC-TN*4PS (3220 Tie-point) 4 Binding posts 5 Cushions</p>  <p>Board: 184.4*190*8.5mm Plate: 240*210*0.8mm</p>

<p>EIC-102BJ</p> 	Breadboard + Jumper Wire Kit	
	Item No.	Component Description
	EIC-102J	EIC-102 + EIC-J-S (70PS Jumper Wires)
	EIC-102BJ	EIC-102B + EIC-J-S (70PS Jumper Wires)
	EIC-104-3J	EIC-104-3 + EIC-J-S (70PS Jumper Wires)
	EIC-104-1J	EIC-104-1 + EIC-J-S (70PS Jumper Wires)
	EIC-104J	EIC-104 + EIC-J-S (70PS Jumper Wires)
	EIC-106J	EIC-106 + EIC-J-L (140PS Jumper Wires)
EIC-108J	EIC-108 + EIC-J-L (140PS Jumper Wires)	

SOLDERLESS BREADBOARD: POM (SILICONE)PLASTIC/ ROUND HOLE

Body material : EIC Brand, POM (Silicone) plastic

Surface : **Light Blue Color**

Heat distortion temperature : **150°C**

Plate material : Metal

Surface : Black

RoHS Compliance

Spring clip contact : Phosphor Bronze

Finish : Nickel plated



Contact life : 50,000 times

Insertion range : 0.4~0.7mm diameter

E.I.C. blister card package

Combines additional boards for larger breadboard available

OEM & Own design is welcome

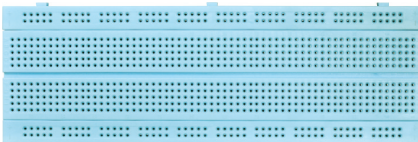
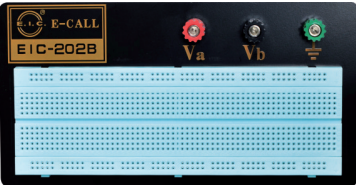
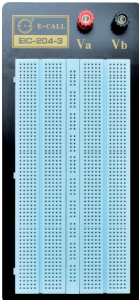
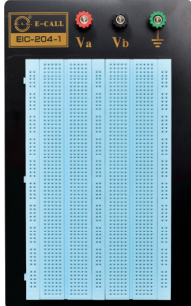
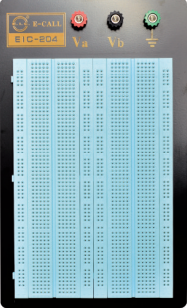
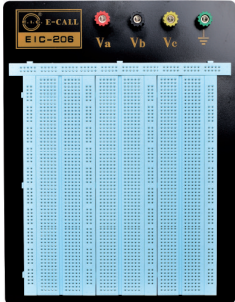
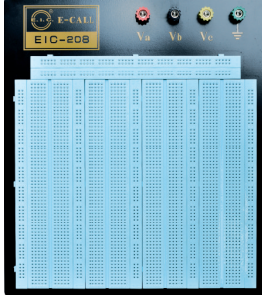
<p>EIC-0210 (100 Tie-point/PC) *2PCS/SET*</p>  <p>Board:165.1*9.4*8.5mm</p>	<p>EIC-0220 (630 Tie-point)</p>  <p>Board:165.1*35.5*8.5mm</p>	<p>EIC-202 (830 Tie-point)</p>  <p>Board: 165.1*54.6*8.5mm Plate: 164*52*0.3mm</p>
<p>EIC-202B</p>  <p>(830 Tie-point) 3 Binding posts, 5 Cushions Board:165.1*54.6*8.5mm Plate: 183*95*0.8mm</p>	<p>EIC-204-3</p> <p>EIC-0210*1PC EIC-0220*2PS (1360 Tie-point) 2 Binding posts 5 Cushions</p>  <p>Board: 165.1*80.8*8.5mm Plate: 215*100*0.8mm</p>	<p>EIC-204-1</p> <p>EIC-0210*3PS EIC-0220*2PS (1560 Tie-point) 3 Binding posts 5 Cushions</p>  <p>Board: 165.1*99.7*8.5mm Plate: 215*130*0.8mm</p>
<p>EIC-204</p> <p>EIC-0210*4PS EIC-0220*2PS (1660 Tie-point) 3 Binding posts 5 Cushions</p>  <p>Board: 165.1*109.3*8.5mm Plate: 215*130*0.8mm</p>	<p>EIC-206</p> <p>EIC-0210*5PS EIC-0220*3PS (2390 Tie-point) 4 Binding posts 5 Cushions</p>  <p>Board: 174.8*165.1*8.5mm Plate: 230*175*0.8mm</p>	<p>EIC-208</p> <p>EIC-0210*7PS EIC-0220*4PS (3220 Tie-point) 4 Binding posts 5 Cushions</p>  <p>Board: 184.4*190*8.5mm Plate: 240*210*0.8mm</p>

<p>EIC-206J</p> 	Breadboard + Jumper Wire Kit	
	Item No.	Component Description
	EIC-202J	EIC-202 + EIC-J-S (70PS Jumper Wires)
	EIC-202BJ	EIC-202B + EIC-J-S (70PS Jumper Wires)
	EIC-204-3J	EIC-204-3 + EIC-J-S (70PS Jumper Wires)
	EIC-204-1J	EIC-204-1 + EIC-J-S (70PS Jumper Wires)
	EIC-204J	EIC-204 + EIC-J-S (70PS Jumper Wires)
	EIC-206J	EIC-206 + EIC-J-L (140PS Jumper Wires)
EIC-208J	EIC-208 + EIC-J-L (140PS Jumper Wires)	

SOLDERLESS BREADBOARD: ABS PLASTIC/ SQUARE HOLE

Body material : EIC Brand, ABS plastic

Surface : Unprinted

Heat distortion temperature : 84°C

Plate material : Metal

Surface : Black

RoHS Compliance

Spring clip contact : Phosphor Bronze

Finish : Nickel plated

Contact life : 50,000 times

Insertion range : 0.4~0.7mm diameter

E.I.C. blister card package

Combines additional boards for larger breadboard available

OEM & Own design is welcome

China Patent NO.: ZL 02 347714 .8

EIC-301
(270 Tie-point)

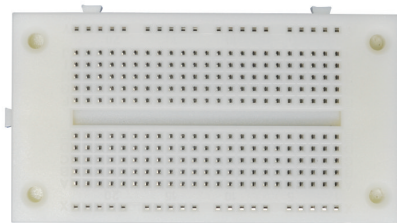

Board: 83.7*45.2*8.5mm

★ INTEGRATED ★

EIC-333
(810 Tie-point)

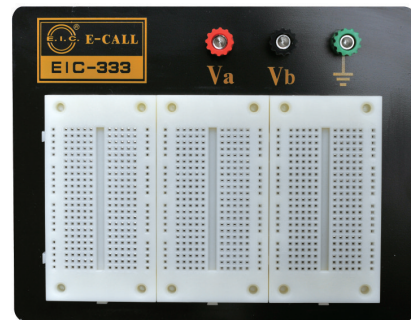

3 Binding posts, 5 Cushions

Board: 83.7*135.6*8.5mm
Plate: 165*130*0.8mm

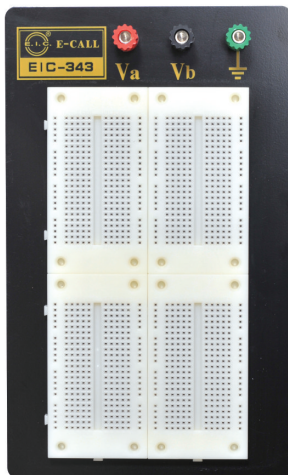

EIC-343
(1080 Tie-point)

3 Binding posts
5 Cushions

Board:
167.4*90.4*8.5mm
Plate:
215*130*0.8mm

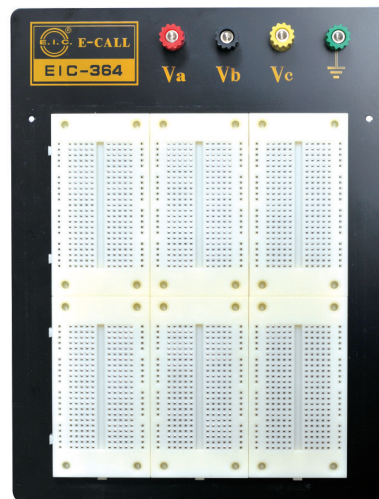

EIC-364
(1620 Tie-point)

4 Binding posts
5 Cushions

Board:
135.6*167.4*8.5mm
Plate:
230*175*0.8mm

SOLDERLESS BREADBOARD: ABS PLASTIC/ SQUARE HOLE

Body material : EIC Brand, ABS plastic

Surface : Colored printing

Heat distortion temperature : 84°C

Plate material : Metal

Surface : Black

RoHS Compliance

Spring clip contact : Phosphor Bronze

Finish : Nickel plated

Contact life : 50,000 times

Insertion range : 0.4~0.7mm diameter

E.I.C. blister card package

Combines additional boards for larger breadboard available

OEM & Own design is welcome

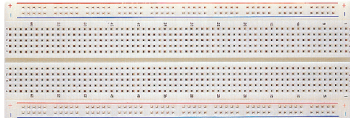
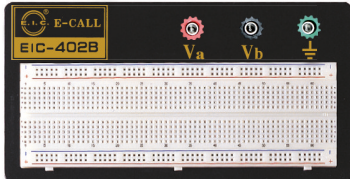
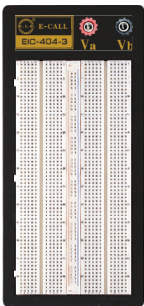
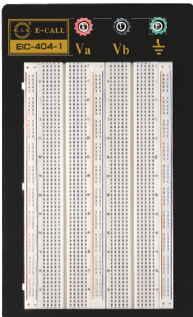
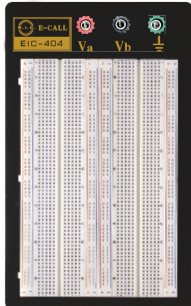
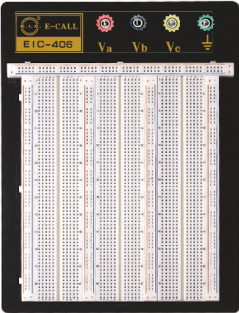
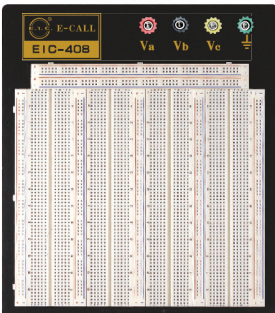
<p>EIC-402</p>  <p>EIC-DN*2PS 640 Terminal Holes*1PC (840 Tie-point)</p> <p>Board: 165.1*54.6*8.5mm Plate: 164*52*0.3mm</p>	<p>EIC-402B</p>  <p>EIC-DN*2PS 640 Terminal Holes*1PC (840 Tie-point) 3 Binding posts 5 Cushions</p> <p>Board: 165.1*54.6*8.5mm Plate: 183*95*0.8mm</p>	
<p>EIC-404-3</p>  <p>EIC-DN*1PC 640 Holes*2PS (1380 Tie-point) 2 Binding posts 5 Cushions</p> <p>Board: 165.1*80.8*8.5mm Plate: 215*100*0.8mm</p>	<p>EIC-404-1</p>  <p>EIC-DN*3PS 640 Holes*2PS (1580 Tie-point) 3 Binding posts 5 Cushions</p> <p>Board: 165.1*99.7*8.5mm Plate: 215*130*0.8mm</p>	<p>EIC-404</p>  <p>EIC-DN*4PS 640 Holes*2PS (1680 Tie-point) 3 Binding posts 5 Cushions</p> <p>Board: 165.1*109.3*8.5mm Plate: 215*130*0.8mm</p>
<p>EIC-406</p>  <p>EIC-DN*5PS 640 Terminal Holes*3PS (2420 Tie-point) 4 Binding posts 5 Cushions</p> <p>Board: 174.8*165.1*8.5mm Plate: 230*175*0.8mm</p>	<p>EIC-408</p>  <p>EIC-DN*7PS 640 Terminal Holes*4PS (3260 Tie-point) 4 Binding posts 5 Cushions</p> <p>Board: 184.4*190*8.5mm Plate: 240*210*0.8mm</p>	

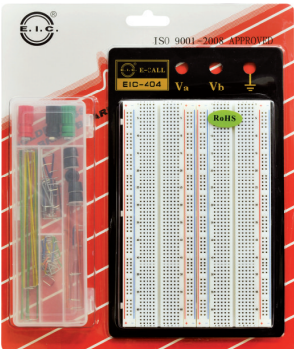
<p>EIC-404J</p> 	Breadboard + Jumper Wire Kit	
	Item No.	Component Description
	EIC-402J	EIC-402 + EIC-J-S (70PS Jumper Wires)
	EIC-402BJ	EIC-402B + EIC-J-S (70PS Jumper Wires)
	EIC-404-3J	EIC-404-3 + EIC-J-S (70PS Jumper Wires)
	EIC-404-1J	EIC-404-1 + EIC-J-S (70PS Jumper Wires)
	EIC-404J	EIC-404 + EIC-J-S (70PS Jumper Wires)
EIC-406J	EIC-406 + EIC-J-L (140PS Jumper Wires)	
EIC-408J	EIC-408 + EIC-J-L (140PS Jumper Wires)	

SOLDERLESS BREADBOARD: ABS PLASTIC/ SQUARE HOLE/ INTEGRATED

Body material : EIC Brand, ABS plastic

Surface : Unprinted

Heat distortion temperature : 84°C

Plate material : Metal

Surface : Black

RoHS Compliance

Spring clip contact : Phosphor Bronze

Finish : Nickel plated

Contact life : 50,000 times

Insertion range : 0.4~0.7mm diameter

E.I.C. blister card package

Combines additional boards for larger breadboard available

OEM & Own design is welcome

EIC-501
(480 Tie-point)

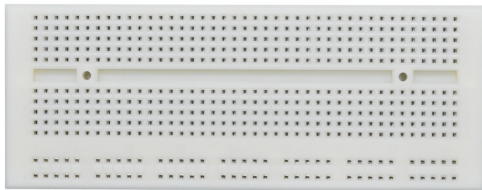

Board: 117*45.2*8.5mm

* Pure ABS Color *

EIC-701
(550 Tie-point)

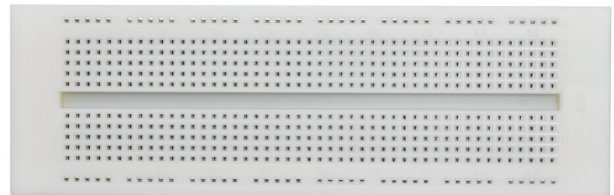

Board: 144.7*46.0*8.5mm

* Pure ABS Color *

EIC-901
(840 Tie-point)

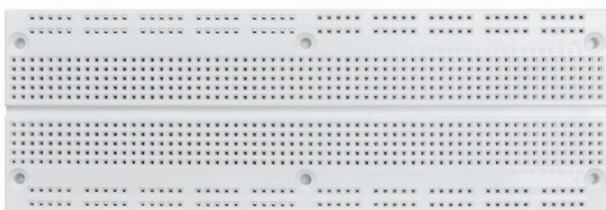

Board: 165.1*55.8*8.5mm

* White ABS Color *

EIC-901B
(840 Tie-point)

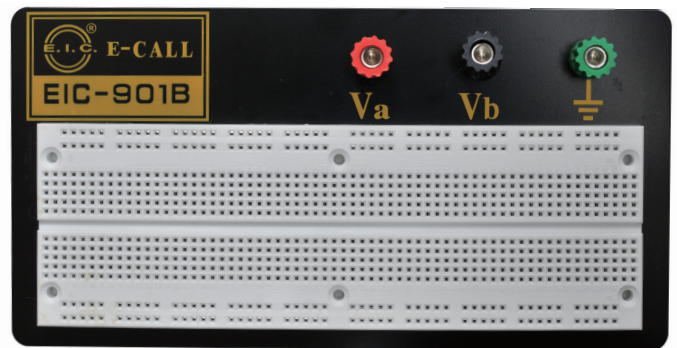

3 Binding posts, 5 Cushions

Board: 165.1*55.8*8.5mm
Plate: 183*95*0.8mm

SOLDERLESS BREADBOARD: ABS PLASTIC/ SQUARE HOLE

Body material : EIC Brand, ABS plastic

Surface : Colored printing

Heat distortion temperature : 84°C

Plate material : Metal

Surface : Black

RoHS Compliance

Spring clip contact : Phosphor Bronze

Finish : Nickel plated

Contact life : 50,000 times

Insertion range : 0.4~0.7mm diameter

E.I.C. blister card package

Combines additional boards for larger breadboard available

OEM & Own design is welcome

EIC-801D (50 Tie-point/PC)

2PCS/SET

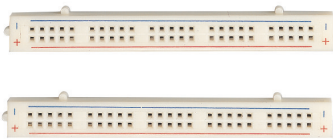

Board: 84.0*9.4*8.5mm

EIC-801T (300 Tie-point)

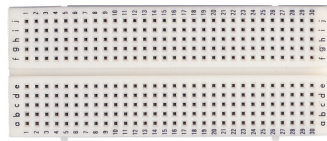

Board: 84.0*35.5*8.5mm

EIC-801 (400 Tie-point)

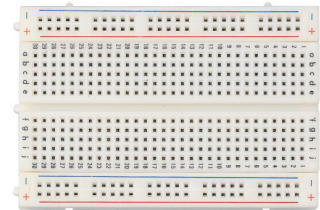

Board: 84.0*54.3*8.5mm

EIC-8021

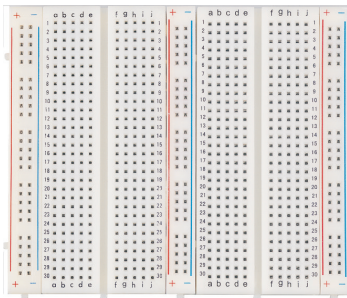

EIC-801D*3PS
EIC-801T*2PS
(750 Tie-point)

Board:
84.0*99.2*8.5mm

EIC-8032

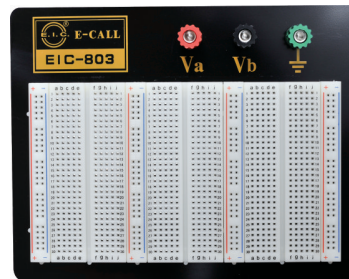

EIC-801D*4PS
EIC-801T*3PS
(1100 Tie-point)
3 Binding posts
5 Cushions

Board:
84.0*144.1*8.5mm
Plate:
165.0*130.0*0.8mm

EIC-8042

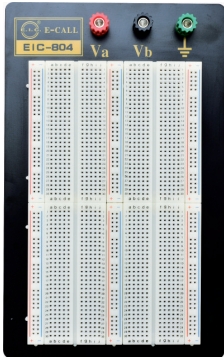

EIC-801D*6PS
EIC-801T*4PS
(1500 Tie-point)
3 Binding posts
5 Cushions

Board:
168.0*99.2*8.5mm
Plate:
215.0*130.0*0.8mm

EIC-8064

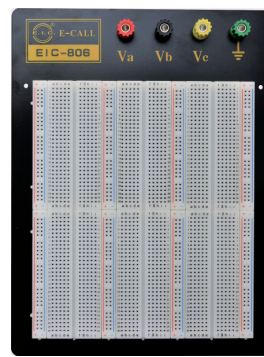

EIC-801D*8PS
EIC-801T*6PS
(2200 Tie-point)
4 Binding posts
5 Cushions

Board:
144.1*168.0*8.5mm
Plate:
230.0*175.0*0.8mm

SOLDERLESS BREADBOARD: ABS PLASTIC/ ROUND HOLE

Body material : EIC Brand, ABS plastic

Surface : Colored printing

Heat distortion temperature : 84°C

Plate material : Metal

Surface : Black

RoHS Compliance

Spring clip contact : Phosphor Bronze

Finish : Nickel plated

Contact life : 50,000 times

Insertion range : 0.4~0.7mm diameter

E.I.C. blister card package

Combines additional boards for larger breadboard available

OEM & Own design is welcome

China Patent NO.: ZL 2004 3 0106004 .5
ZL 2004 2 0110937.6

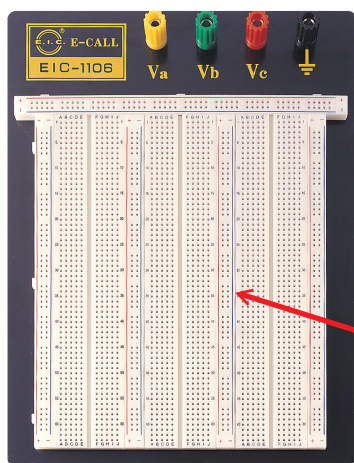

EIC-1102 (830 Tie-point)

Terminal holes 630*1PC + Distribution holes 100*2PS

Board: 165.1*54.6*8.5mm

Plate: 164*52*0.3mm

EIC-1104 (1660 Tie-point)

Terminal holes 630*2PS + Distribution holes 100*4PS
3 Binding posts, 5 Cushions

Board: 165.1*109.3*8.5mm

Plate: 215*130*0.8mm

EIC-1106 (2390 Tie-point)

Terminal holes 630*3PS + Distribution holes 100*5PS
4 Binding posts, 5 Cushions

Board: 174.8*165.1*8.5mm

Plate: 230*175*0.8mm

EIC-1108 (3220 Tie-point)

Terminal holes 630*4PS + Distribution holes 100*7PS
4 Binding posts, 5 Cushions

Board: 184.4*190*8.5mm

Plate: 240*210*0.8mm

EIC-1104-8 ★TRANSPARENT★

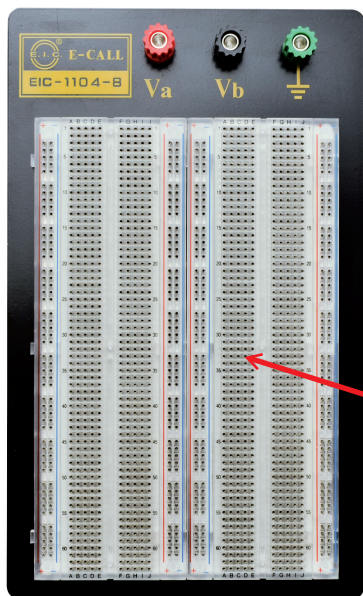

EIC-1102-8 (830 Tie-point) / TRANSPARENT

Terminal holes 630*1PC + Distribution holes 100*2PS

Board: 165.1*54.6*8.5mm

Plate: 164*52*0.3mm

EIC-1104-8 (1660 Tie-point)/ TRANSPARENT

Terminal holes 630*2PS + Distribution holes 100*4PS
3 Binding posts, 5 Cushions

Board: 165.1*109.3*8.5mm

Plate: 215*130*0.8mm

EIC-1106-8 (2390 Tie-point)/ TRANSPARENT

Terminal holes 630*3PS + Distribution holes 100*5PS
4 Binding posts, 5 Cushions

Board: 174.8*165.1*8.5mm

Plate: 230*175*0.8mm

EIC-1108-8 (3220 Tie-point)/ TRANSPARENT

Terminal holes 630*4PS + Distribution holes 100*7PS
4 Binding posts, 5 Cushions

Board: 184.4*190*8.5mm

Plate: 240*210*0.8mm

SOLDERLESS BREADBOARD: ABS PLASTIC/ SQUARE HOLE/ WITH TERMINAL BLOCKS

Body material : EIC Brand, ABS plastic

Surface : Colored printing

Heat distortion temperature : 84°C

Plate material : Metal

Surface : Black

RoHS Compliance

Spring clip contact : Phosphor Bronze

Finish : Nickel plated

Contact life : 50,000 times

Insertion range : 0.4~0.7mm diameter

E.I.C. blister card package

Combines additional boards for larger breadboard available

OEM & Own design is welcome

◆ WITH TERMINAL BLOCKS ◆

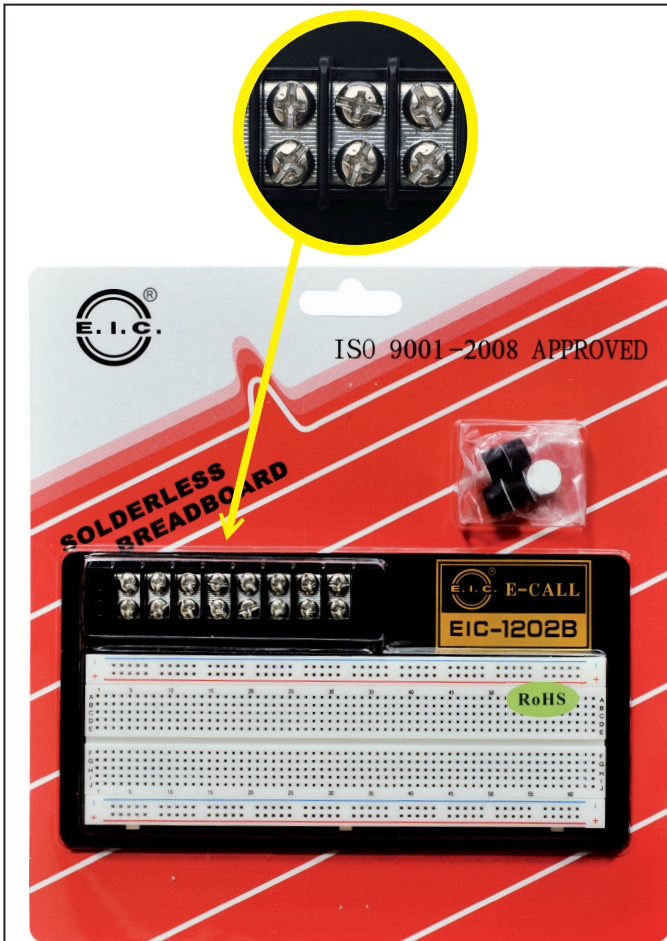

**EIC-1202B
(830 Tie-point)**



**EIC-1204-1B
(1560 Tie-point)**

EIC-DN (100 Tie-point)*2PS
EIC-TN (630 Tie-point)*1PC

2*8 Terminal Blocks
5 Cushions

Board: 165.1*54.6*8.5mm
Plate: 183*95*0.8mm

EIC-DN (100 Tie-point)*3PS
EIC-TN (630 Tie-point)*2PS

2*8 Terminal Blocks
5 Cushions

Board: 165.1*99.7*8.5mm
Plate: 183*160*0.8mm

SOLDERLESS BREADBOARD: ABS PLASTIC/ SQUARE HOLE/ TRANSPARENT

Body material : EIC Brand, ABS plastic

Surface : Colored printing

Heat distortion temperature : 84°C

Plate material : Metal

Surface : Black

RoHS Compliance

Spring clip contact : Phosphor Bronze

Finish : Nickel plated

Contact life : 50,000 times



Insertion range : 0.4~0.7mm diameter

E.I.C. blister card package

Combines additional boards for larger breadboard available

OEM & Own design is welcome

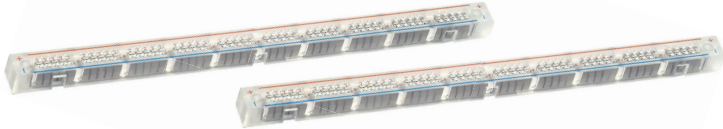
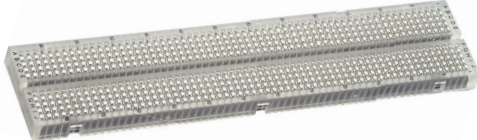
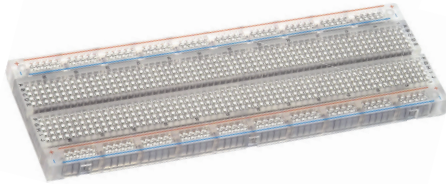

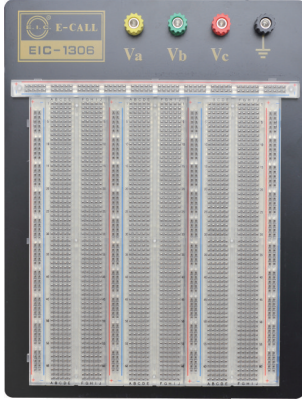
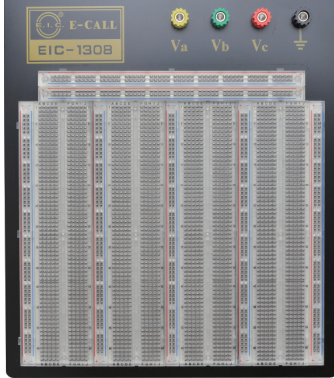
	<p>EIC-130DN (100 Tie-point)/PC *2PS/SET* Board: 165.1*9.4*8.5mm</p>
	<p>EIC-130TN (630 Tie-point) Board: 165.1*35.5*8.5mm</p>
	<p>EIC-1302 (830 Tie-point) EIC-130DN*2PS + EIC-130TN*1PC Board: 165.1*54.6*8.5mm Plate: 164*52*0.3mm</p>
 <p>EIC-1304-3 (1360 Tie-point) EIC-130DN*1PC EIC-130TN*2PS 2 Binding posts 5 Cushions Board: 165.1*80.8*8.5mm Plate: 215*100*0.8mm</p>	 <p>EIC-1304 (1660 Tie-point) EIC-130DN*4PS EIC-130TN*2PS 3 Binding posts 5 Cushions Board: 165.1*109.3*8.5mm Plate: 215*130*0.8mm</p>
 <p>EIC-1306 (2390 Tie-point) EIC-130DN*5PS EIC-130TN*3PS 4 Binding posts 5 Cushions Board: 174.8*165.1*8.5mm Plate: 230*175*0.8mm</p>	 <p>EIC-1308 (3220 Tie-point) EIC-130DN*7PS EIC-130TN*4PS 4 Binding posts 5 Cushions Board: 184.4*190*8.5mm Plate: 240*210*0.8mm</p>

SOLDERLESS BREADBOARD: POM PLASTIC/ ROUND HOLE/ EIC-15010

Body material : EIC Brand, POM plastic

Surface : Unprinted

Heat distortion temperature : 150°C

Terminal holes : 170 holes

RoHS Compliance

Spring clip contact : Phosphor Bronze

Finish : Nickel plated

Contact life : 50,000 times

Insertion range : 0.4~0.7mm diameter

E.I.C. blister card package

Combines additional boards for larger breadboard available

OEM & Own design is welcome

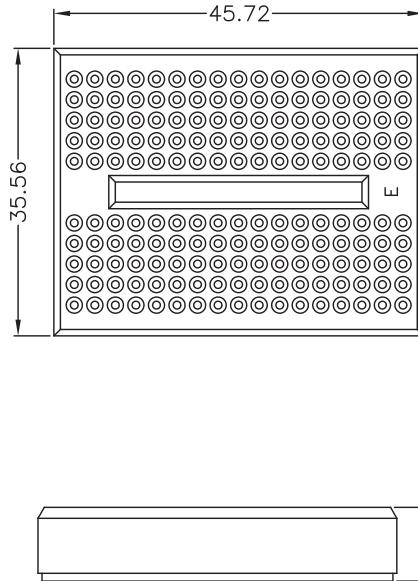

**** WITH 2 PCS SCREWS ****

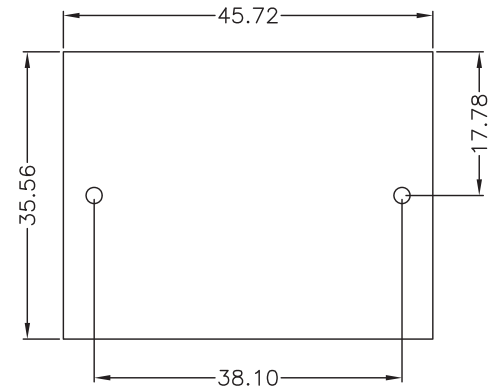

Color options:



WHITE



BLACK

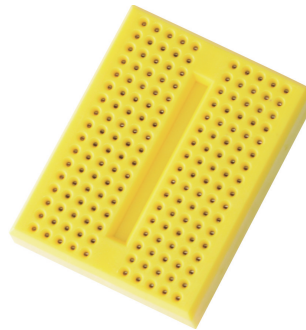

YELLOW



TRANSPARENT (ABS)

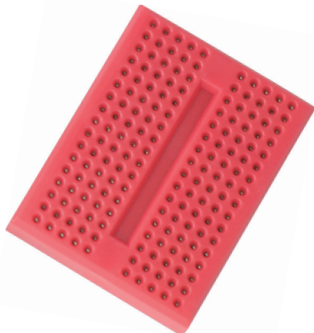

RED

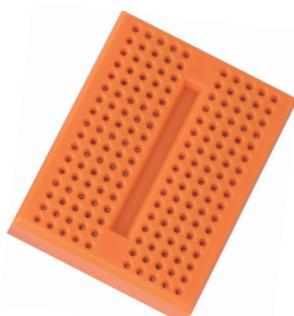

ORANGE

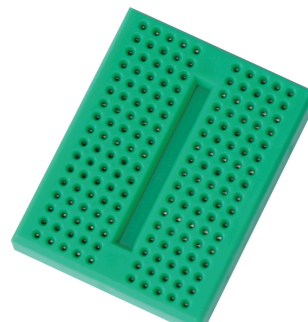

GREEN



BLUE

SOLDERLESS BREADBOARD SIMPLE TYPE !

RoHS Compliance

- ★ Easy to Combine Together ★
- ★ Assemble to Variety Size ★
- ★ Easy to Use ★

ROUND HOLE

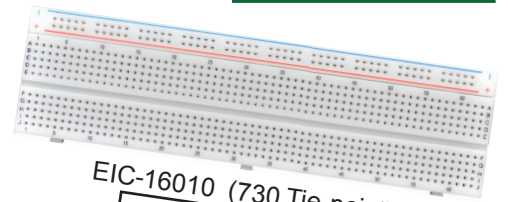

EIC-16010 (730 Tie-point)
167.1*45.0*15.2mm

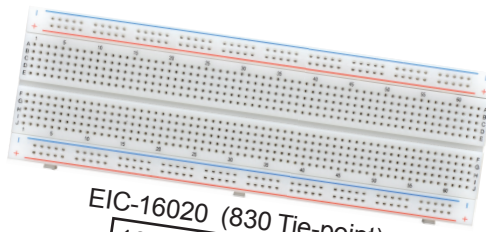

EIC-16020 (830 Tie-point)
167.1*54.4*15.2mm

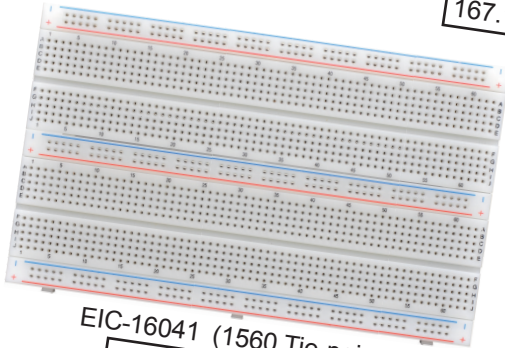

EIC-16041 (1560 Tie-point)
167.1*101.7*15.2mm

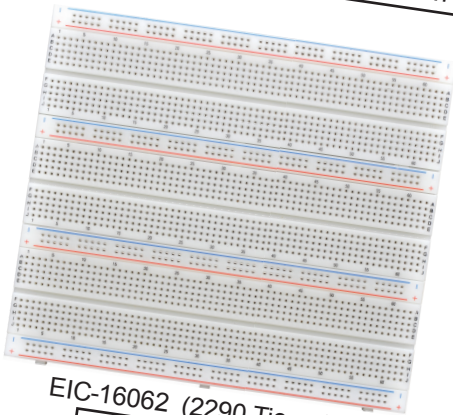

EIC-16062 (2290 Tie-point)
167.1*146.0*15.2mm

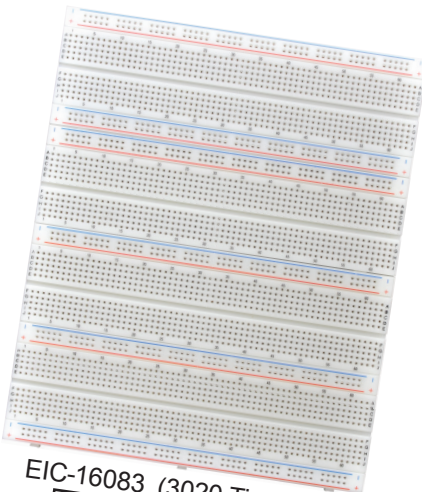

EIC-16083 (3020 Tie-point)
167.1*191.0*15.2mm

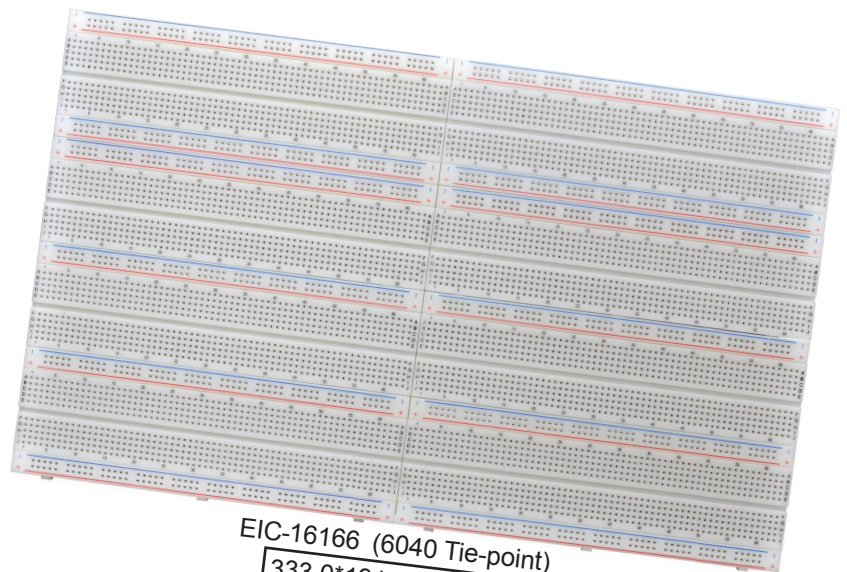

EIC-16166 (6040 Tie-point)
333.0*191.0*15.2mm

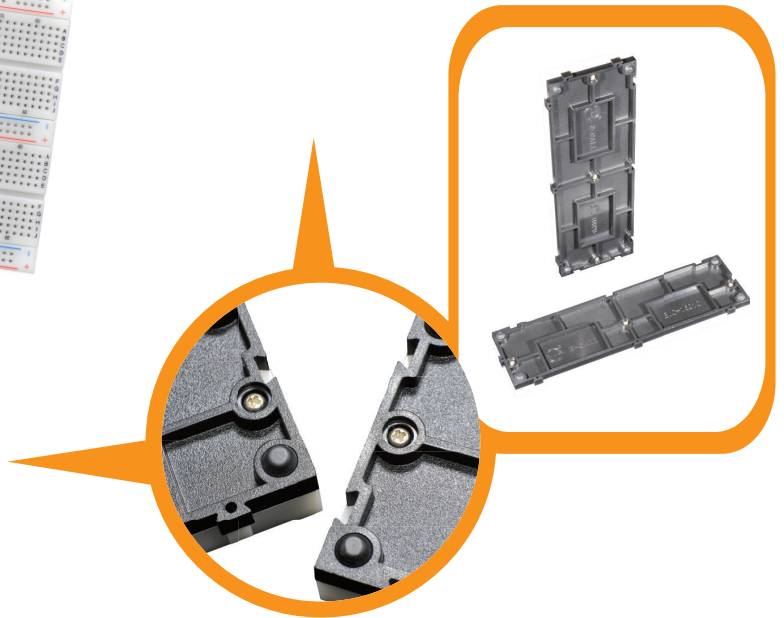

SOLDERLESS BREADBOARD: ABS PLASTIC/ROUND HOLE/FOR USA MARKET

Body material : EIC Brand, ABS plastic

Surface : Colored printing

Heat distortion temperature : 84°C

Plate material :Metal

Surface : Black

RoHS Compliance

Spring clip contact : Phosphor Bronze

Finish : Nickel plated



Contact life : 50,000 times

Insertion range : 0.4~0.7mm diameter

E.I.C. blister card package

Combines additional boards for larger breadboard available

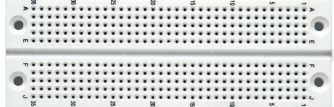
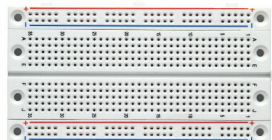
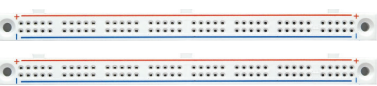
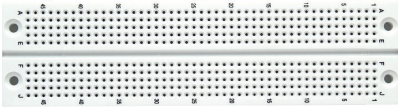
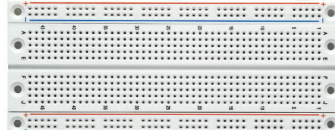
OEM & Own design is welcome

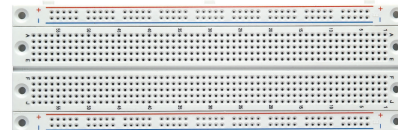
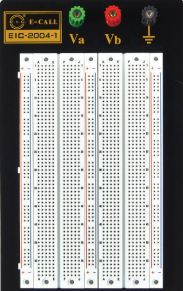
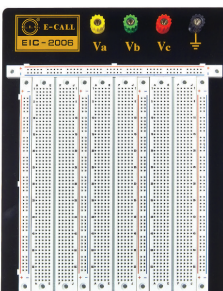
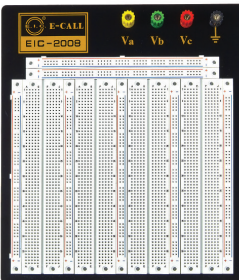
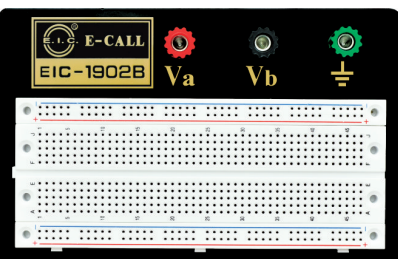
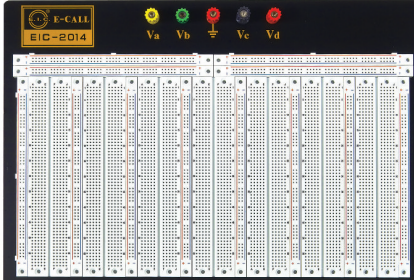
<p>EIC-180DN (60 Tie-point/PC) *2PCS/SET*</p>  <p>Board:104.14*9.4*8.5mm</p>	<p>EIC-180TN (350 Tie-point)</p>  <p>Board:104.14*35.6*8.5mm</p>	<p>EIC-18020 (470 Tie-point)</p>  <p>Board: 104.14*54.4*8.5mm</p>
<p>EIC-190DN(80 Tie-point/PC) *2PCS/SET*</p>  <p>Board:134.62*9.4*8.5mm</p>	<p>EIC-190TN (470 Tie-point)</p>  <p>Board:134.62*35.6*8.5mm</p>	<p>EIC-19020 (630 Tie-point)</p>  <p>Board: 134.62*54.4*8.5mm</p>
<p>EIC-200DN(90 Tie-point/PC) *2PCS/SET*</p>  <p>Board:165.1*9.4*8.5mm</p>	<p>EIC-200TN (590 Tie-point)</p>  <p>Board:165.1*35.6*8.5mm</p>	<p>EIC-20020 (770 Tie-point)</p>  <p>Board: 165.1*54.4*8.5mm</p>
<p>EIC-2004-1</p>  <p>EIC-200DN*3PS EIC-200TN*2PS (1450 Tie-pont) 3 Binding posts 5 Cushions</p> <p>Board: 165.1*99.7*8.5mm Plate: 215*130*0.8mm</p>	<p>EIC-2006</p>  <p>EIC-200DN*5PS EIC-200TN*3PS (2220 Tie-pont) 4 Binding posts 5 Cushions</p> <p>Board: 165.1*174.8*8.5mm Plate: 230*175*0.8mm</p>	<p>EIC-2008</p>  <p>EIC-200DN*7PS EIC-200TN*4PS (2990 Tie-pont) 4 Binding posts 5 Cushions</p> <p>Board: 189.4*184.4*8.5mm Plate: 240*210*0.8mm</p>
<p>EIC-1902B</p>  <p>EIC-190DN*2PS EIC-190TN*1PC (630 Tie-pont) 3 Binding posts 5 Cushions</p> <p>Board: 134.6*54.4*8.5mm Plate: 150*95*0.8mm</p>		<p>EIC-2014</p>  <p>EIC-200DN*12PS EIC-200TN*7PS (5210 Tie-pont) 5 Binding posts 5 Cushions</p> <p>Board: 324.4*184.4*8.5mm Plate: 240*350*0.8mm</p>

SOLDERLESS BREADBOARD: ABS PLASTIC/ SQUARE HOLE / SLIDE TYPE

Body material : EIC Brand, ABS plastic

Surface : Colored printing

Heat distortion temperature : 84°C

E.I.C. blister card package

Spring clip contact : Phosphor Bronze

Finish : Nickel plated

Contact life : 50,000 times

Insertion range : 0.4~0.7mm diameter

RoHS Compliance

Combines additional boards for larger breadboard available

OEM & Own design is welcome

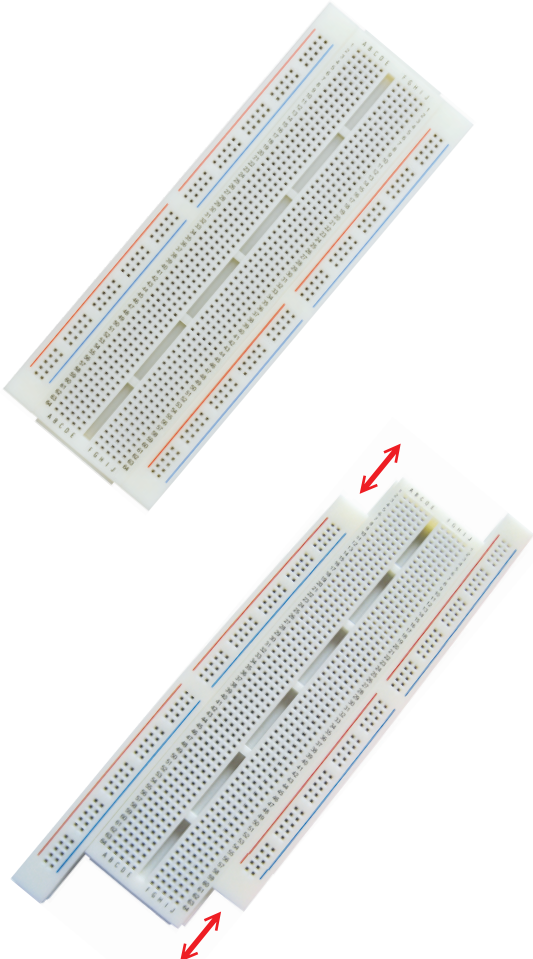
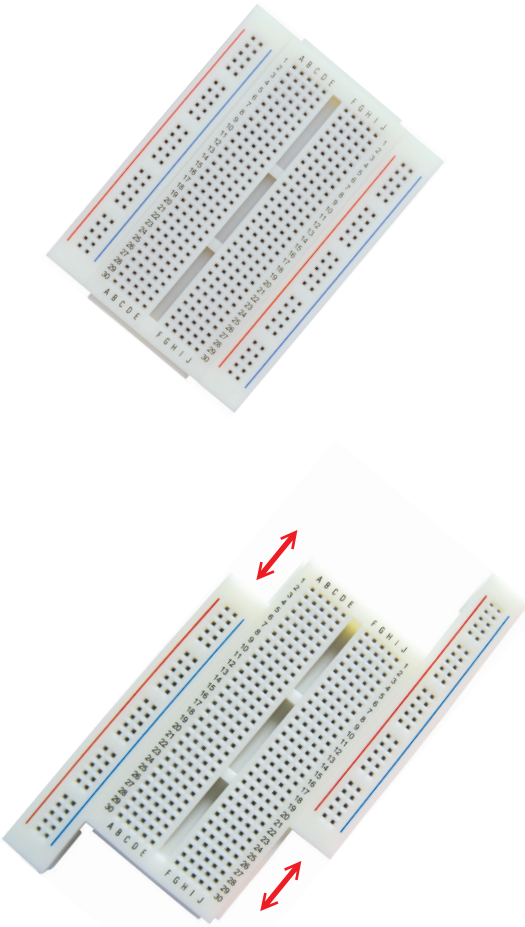
<p style="text-align: center;">Slide Type!</p> 	<p style="text-align: center;">Slide Type!</p> 
<p style="text-align: center;">EIC-2702</p> <p style="text-align: center;">Terminal holes 640*1PC Distribution holes 100*2PS (840 Tie-point)</p> <p style="text-align: center;">Board: 172.7*64.5*8.5mm</p>	<p style="text-align: center;">EIC-2801</p> <p style="text-align: center;">Terminal holes 300*1PC Distribution holes 50*2PS (400 Tie-point)</p> <p style="text-align: center;">Board: 86.5*64.5*8.5mm</p>

SOLDER TYPE BREADBOARD: ABS PLASTIC/ ROUND HOLE/ SMALL SIZE

Body material : ABS plastic

Heat distortion temperature : 84°C

Packing : Tray packing

RoHS Compliance

Spring clip contact : Phosphor Bronze

Finish : Nickel plated

Contact life : 50,000 times

Insertion range : 0.4~0.7mm diameter

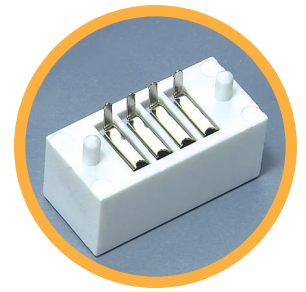

☆**Spring clip with solder tail**

☆**Ideal for sophisticated digital training/ test system**

☆**Can insert to board which has built-in circuit and be connected**

0165-4014-7-21010
(4*2=8 Tie-point)

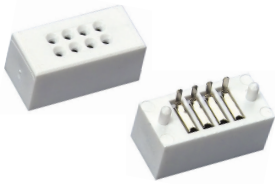

18.4*8.4*8.4mm

0165-4014-7-22010
(8*2=16 Tie-point)



28.5*8.4*8.4mm

0165-4014-7-23010
(16*2=32 Tie-point)

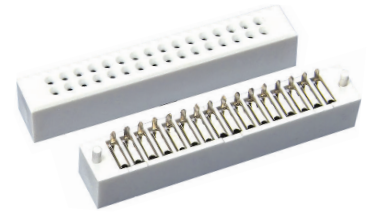

48.8*8.4*8.4mm

0165-4015-7-24010
(5*8=40 Tie-point)

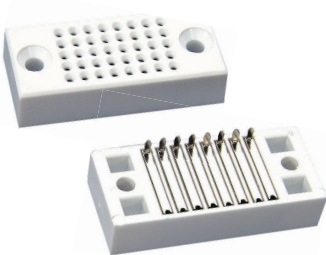

*** WITH 2 PCS SCREWS ***

36.0*16.0*8.4mm

0165-4015-2-25010
(5*33=165 Tie-point)

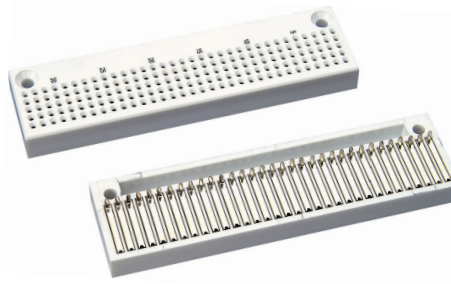

*** WITH 2 PCS SCREWS ***

87.0*23.0*8.4mm

0165-4015-7-200DN
(10*9=90 Tie-point)

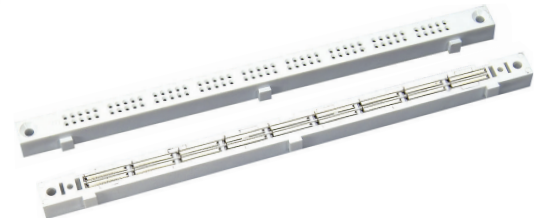

*** WITH 2 PCS SCREWS ***

16.51*9.4*8.4mm

☆**Conduct from 1~4 holes**☆

0165-4014-7-36010
(4*2=8 Tie-point)



17.78*7.62*8.4mm

0165-4014-7-37010
(4*3=12 Tie-point)



17.78*10.16*8.4mm

0165-4014-7-38010
(4*4=16 Tie-point)



17.78*12.7*8.4mm

TERMINAL BLOCK *SQUARE HOLE*

*L.E.D. indicators not included

*Polybag pack

0165-45-7-6020
(2 Tie-point)



17.8*7.8*8.4mm

0165-45-7-6050
(5-Tie-point)



17.8*5.1*8.4mm

SOLDER TYPE BREADBOARD: ABS PLASTIC/ ROUND HOLE

Body material : ABS plastic

Heat distortion temperature : 84°C

Packing : Tray packing

RoHS Compliance

Spring clip contact : Phosphor Bronze

Finish : Nickel plated

Contact life : 50,000 times

Insertion range : 0.4~0.7mm diameter



0165-4014-2-35010
(4*27=108 Tie-point)

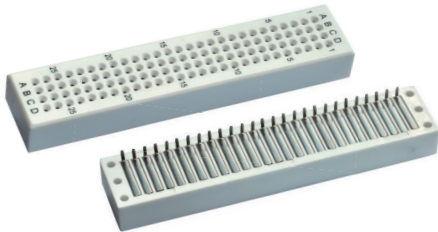

76.2*16.0*8.4mm

0165-4014-2-34010
(4*54=216 Tie-point)



165.1*16.0*8.4mm

WITHOUT SOLDER TAIL
0165-40-2-34010

SOLDERLESS BREADBOARD: ABS PLASTIC/ ROUND HOLE

Plate material : Metal

Packing : E.I.C. blister card package

Surface : Black

RoHS Compliance



EIC-3201
(840 Tie-point)

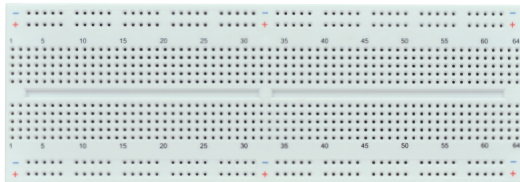

Board: 165.1*57.15*8.4mm

EIC-3301
(610 Tie-point)

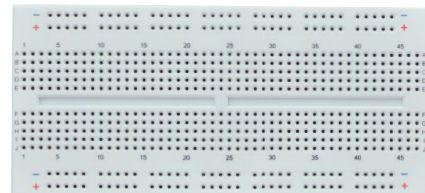

Board: 124.46*57.15*8.4mm

EIC-3201B
(840 Tie-point)

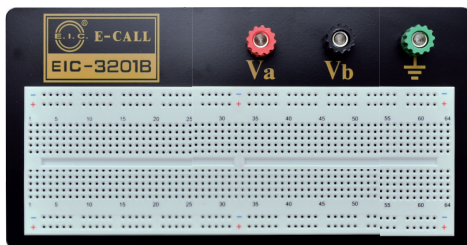

3 Binding posts, 5 Cushions

Board: 165.1*57.15*8.4mm
Plate: 183*95*0.8mm

EIC-3301B
(610 Tie-point)

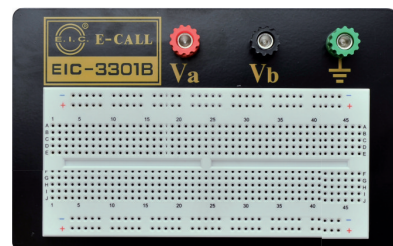

3 Binding posts, 5 Cushions

Board: 124.46*57.15*8.4mm
Plate: 150*95*0.8mm

MACHINE PIN JUMPER WIRE

Specification : UL1007, #24AWG

RoHS Compliance

- ☆ Easy for insertion, extraction
- ☆ No distortion after repeatedly usage
- ☆ Flexible wires enable constantly bend when operation
- ☆ Variety colors/length available

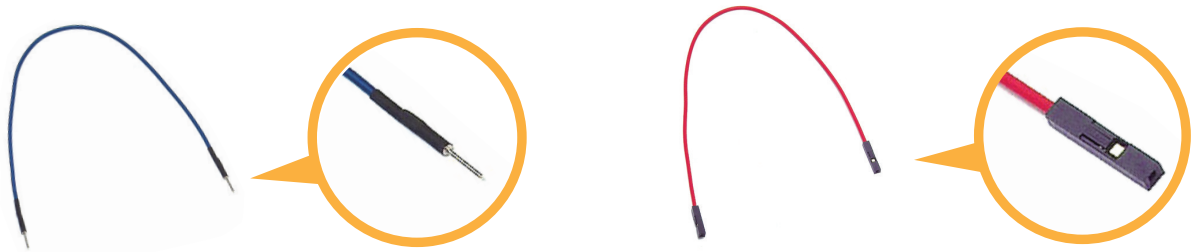

Spec. & Image Standard Length & Color	Male-Male	Male-Female	Female-Female
50mm (BROWN)	0116-719-06-005	0116-71904-06-005	0116-71905-06-005
70mm (GRAY)	0116-719-08-007	0116-71904-08-007	0116-71905-08-007
100mm (ORANGE)	0116-719-07-010	0116-71904-07-010	0116-71905-07-010
150mm (PURPLE)	0116-719-11-015	0116-71904-11-015	0116-71905-11-015
200mm (BLUE)	0116-719-02-020	0116-71904-02-020	0116-71905-02-020

Color options of machine pin jumper wire :

RED/ BLUE/ YELLOW/ GREEN/ BLACK/ BROWN/ ORANGE/ GRAY/ WHITE/ PURPLE

Packing : 10 pcs/pack (EIC Card Package)



MACHINE PIN JUMPER WIRE/0.025" CONTINUOUS JUMPERS (Daisy Chain Cable)

>>Save Time and Money by Eliminating Stripping and Crimping<<

★ M-M & F-F available★

※Custom-made size & nodes are welcome※

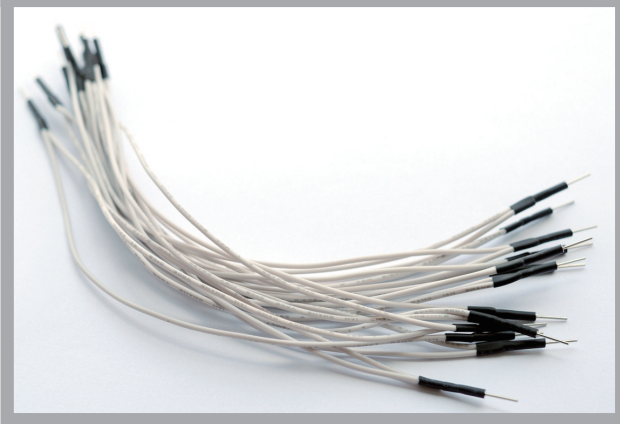
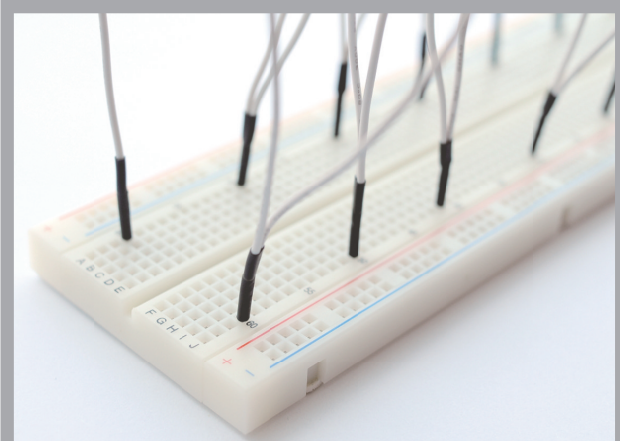

Male-Male (0116-719261-09-015)

- Rolls of slip-on contacts, 15mm apart
- UL1007, **26AWG** wire
- Connector Machine pin 0.63mm (Brass)
- Slips onto 0.025" square posts (Breadboard size)
- 30 nodes (Standard)/ EIC Card Package
- Color option
- RoHS Compliance

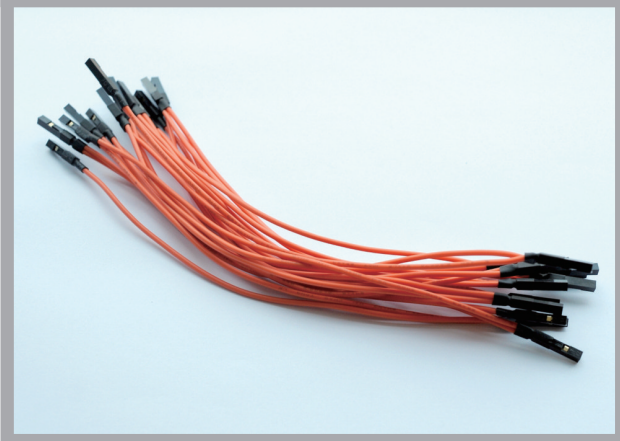
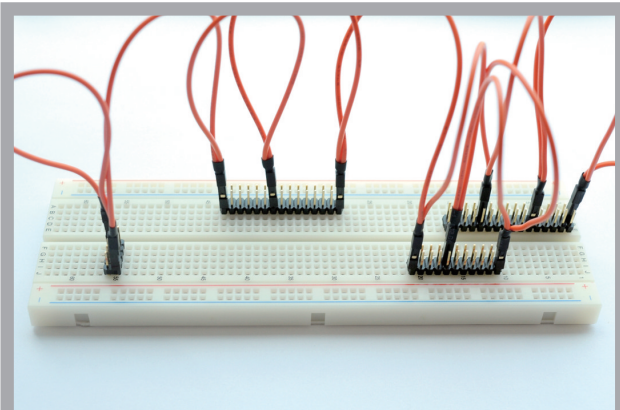
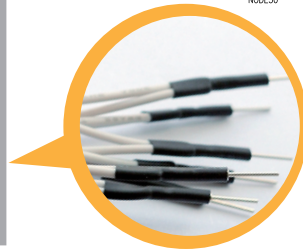
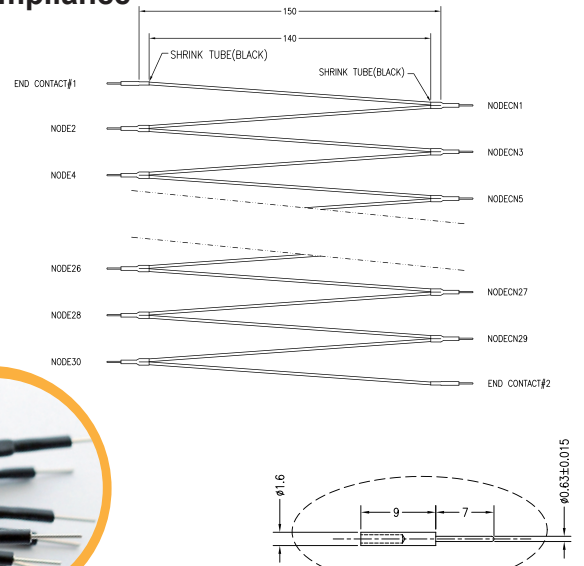

Female-Female (0116-719262-07-015)

- Rolls of slip-on contacts, 15mm apart
- UL1007, **24AWG** wire
- Terminal 2.54mm Gold plated
- Slips onto 0.025" square posts (Breadboard size)
- 30 nodes (Standard)/ EIC Card Package
- Color option
- RoHS Compliance

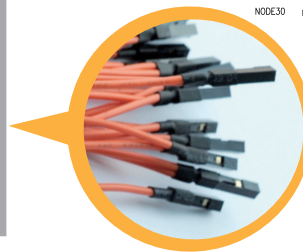
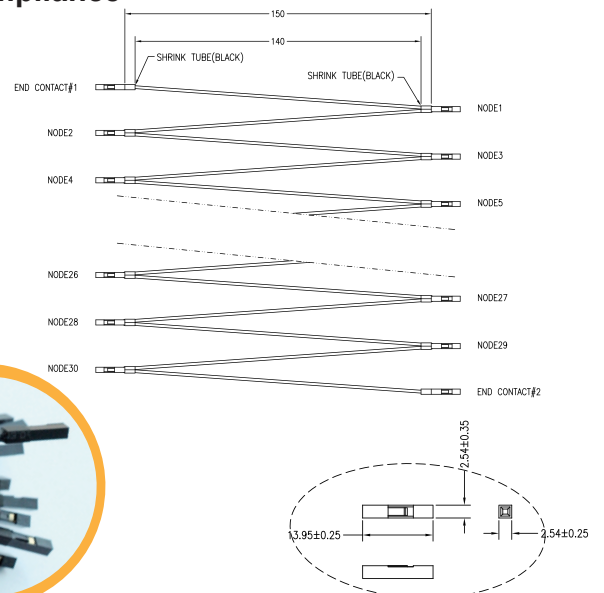

JUMPER WIRE KIT

A perfect kit contains 14 sizes of colorful solid 22 AWG wire jumpers

Each jumper with stripped and right-angled ends for easy use for breadboards

Supplied in an excellent plastic case for well-assortment

RoHS Compliance

P.P Plastic Box Advantage

- ★ MORE FLEXIBLE & SOFTER ★
- ★ NOT EASY BROKEN ★
- ★ NOT EASY GETTING SCRATCHES ★



EIC-J-XL(350pcs)



EIC-J-L(140pcs)

EIC-J-S(70pcs)

22 AWG solid wires

Pre-cut, Pre Stripped and Preformed on each end.

Variety colors, 14 lengths (2.5/5.1/7.7/10.3/12.7/15.3/17.8/20.1/22.8/25.4/51.3/76.3/101.3 and 126.3mm)± 0.2mm

Completely Reusable

Item no.	Description	Box (mm)
EIC-J-XL	350pcs jumper wires (14 lengths x 25pcs each)	205x145x40 (Item no. 0021-002-350)
EIC-J-L	140pcs jumper wires (14 lengths x 10pcs each)	168x55.5x14.5
EIC-J-S	70pcs jumper wires (14 lengths x 5pcs each)	168x55.5x14.5











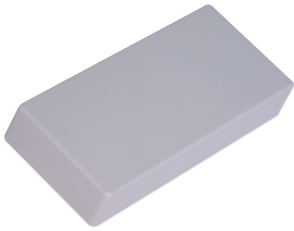
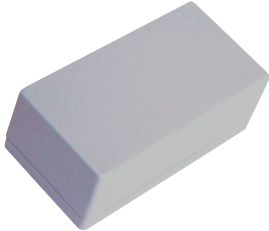
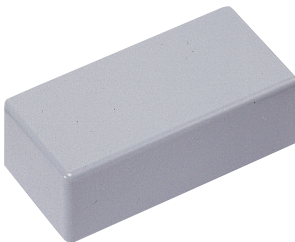

CABINET

Box will not crack or split when drilled or punched, enclosed with four screws and lid

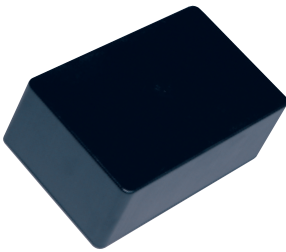
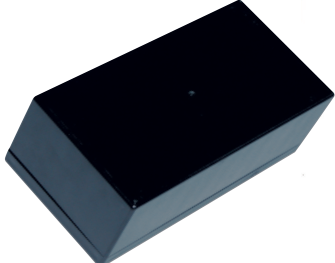
Material by ABS plastic in foggy surface

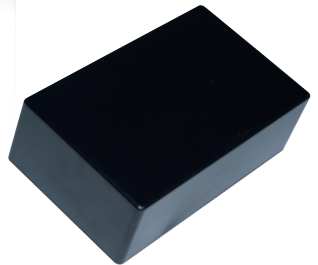
Anti-static/RoHS Compliance

Standard Color: Black Optional Color: Gray, Beige

<p>0021-002-205 (GRAY)</p>  <p>65mm*45mm*35mm</p>	<p>0021-002-165 (GRAY)</p>  <p>76mm*50mm*27mm</p>	<p>0021-002-195 (GRAY)</p>  <p>89mm*89mm*57mm</p>	<p>0021-002-093 (BLACK)</p>  <p>95mm*48mm*37mm</p>	<p>0021-002-173 (BLACK)</p>  <p>102mm*77mm*41mm</p>
<p>0021-002-015 (GRAY)</p>  <p>112mm*57mm*22mm</p>	<p>0021-002-105 (GRAY)</p>  <p>115mm*60mm*44mm</p>	<p>0021-002-035 (GRAY)</p>  <p>129mm*64mm*45mm</p>	<p>0021-002-113 (BLACK)</p>  <p>135mm*75mm*49mm</p>	
<p>0021-002-023 (BLACK)</p>  <p>150mm*99mm*60mm</p>	<p>0021-002-123 (BLACK)</p>  <p>160mm*95mm*62mm</p>	<p>0021-002-185 (GRAY)</p>  <p>169mm*108mm*78mm</p>	<p>0021-002-043 (BLACK)</p>  <p>185mm*114mm*66mm</p>	
<p>0021-002-074 (GRAY+BEIGE)</p>  <p>196mm*110mm*36mm</p>	<p>0021-002-084 (GRAY+BEIGE)</p>  <p>195mm*110mm*76mm</p>	<p>0021-002-133 (BLACK)</p>  <p>193mm*115mm*75mm</p>	<p>0021-002-143 (BLACK)</p>  <p>223mm*139mm*92mm</p>	

Prototype Breadboard Of An Electronic Circuit And For Experimenting With Circuit Designs

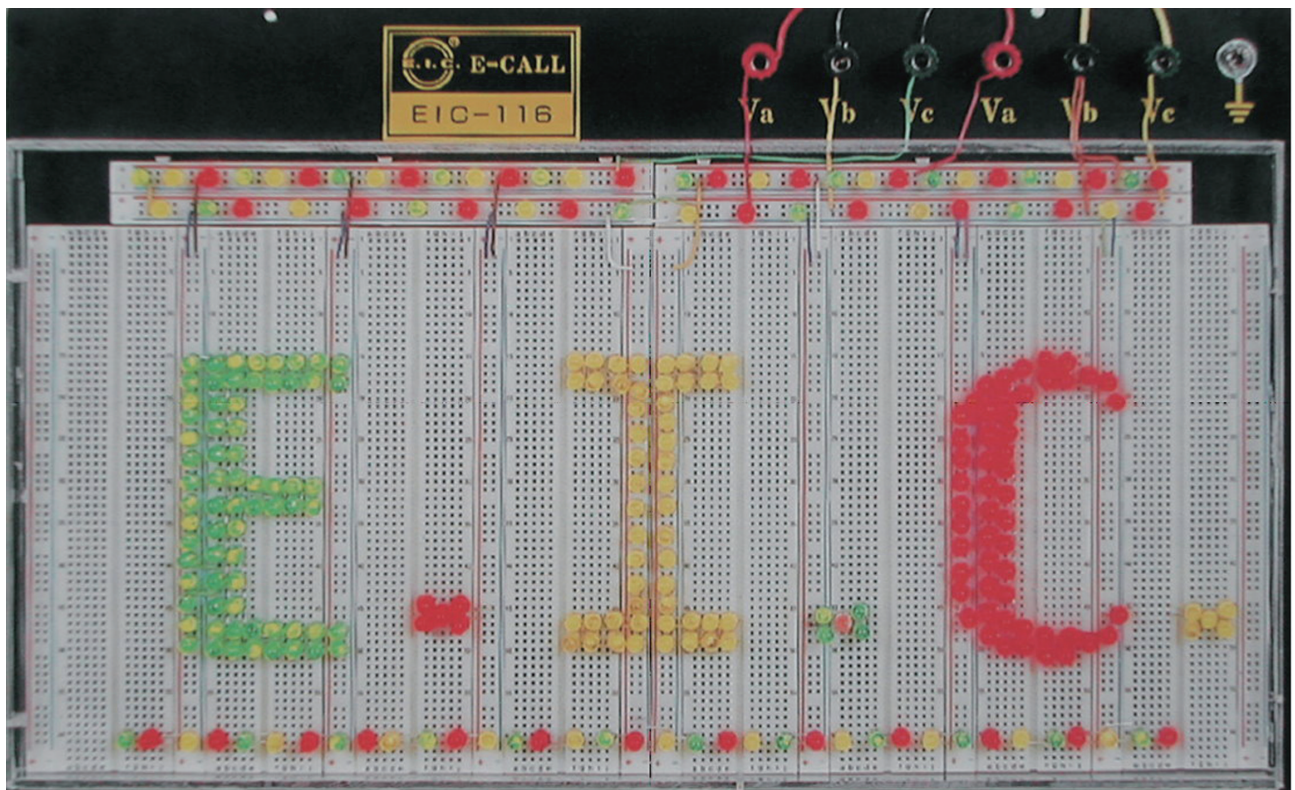
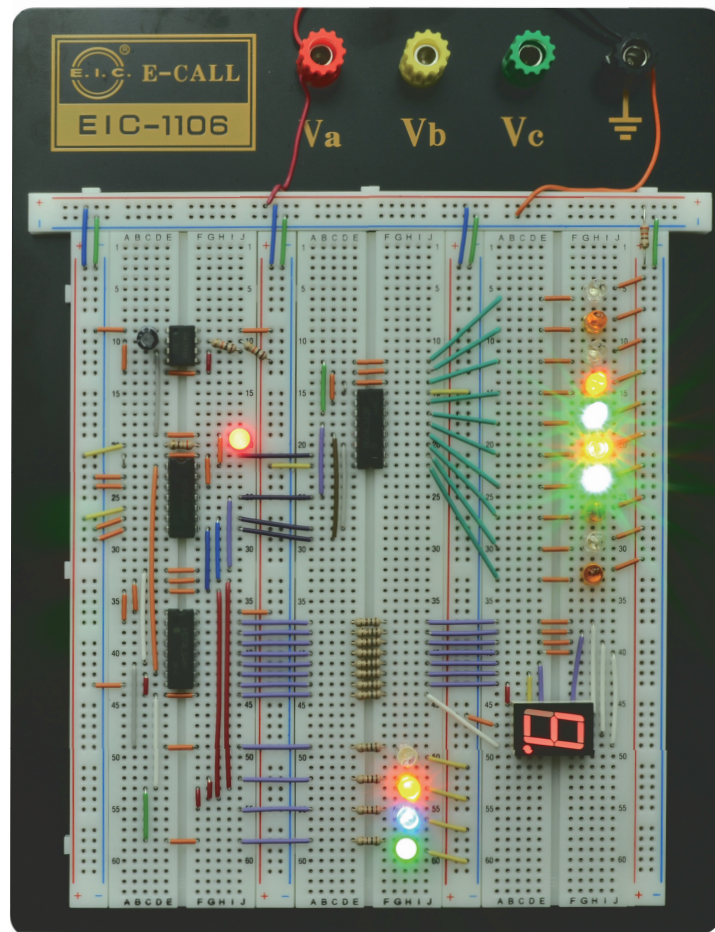

NOTE