

BCR1AM-8

LOW POWER USE
PLANAR PASSIVATION TYPE

BCR1AM-8



- I_T (RMS) 1.0A
- V_{DRM} 400V
- I_{FGT} I 5mA
- I_{RGT} I , I_{RGT} III 5mA (3mA) *5
- I_{FGT} III 10mA

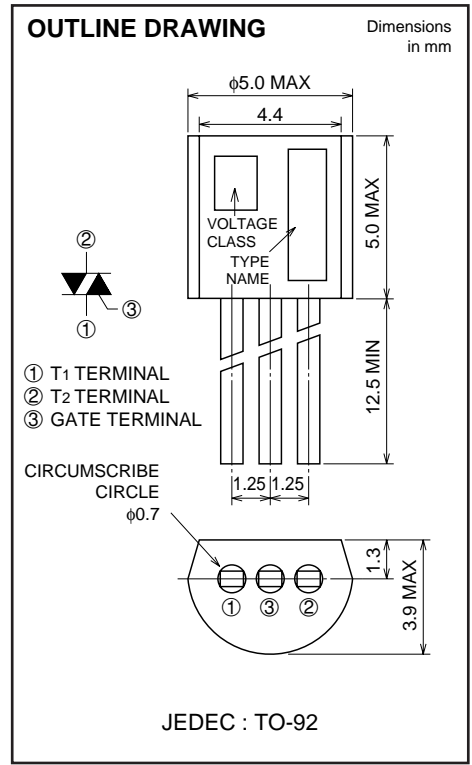

APPLICATION

Contactless AC switches, heating, refrigerator, washing machine, electric fan, vending machines, trigger circuit for low and medium triac, solid state relay, other general purpose control applications

MAXIMUM RATINGS

Symbol	Parameter	Voltage class		Unit
		8		
V_{DRM}	Repetitive peak off-state voltage *1	400		V
V_{DSM}	Non-repetitive peak off-state voltage *1	500		V

Symbol	Parameter	Conditions	Ratings	Unit
I_T (RMS)	RMS on-state current	Commercial frequency, sine full wave 360° conduction, $T_c=56^\circ\text{C}$ *4	1.0	A
I_{TSM}	Surge on-state current	60Hz sinewave 1 full cycle, peak value, non-repetitive	10	A
I_t^2	I_t^2 for fusing	Value corresponding to 1 cycle of half wave 60Hz, surge on-state current	0.41	A ² s
PGM	Peak gate power dissipation		1	W
PG (AV)	Average gate power dissipation		0.1	W
VGM	Peak gate voltage		6	V
IGM	Peak gate current		1	A
T_j	Junction temperature		-40 ~ +125	°C
T_{stg}	Storage temperature		-40 ~ +125	°C
—	Weight	Typical value	0.23	g

*1. Gate open.

BCR1AM-8

**LOW POWER USE
PLANAR PASSIVATION TYPE**

ELECTRICAL CHARACTERISTICS

Symbol	Parameter	Test conditions	Limits			Unit	
			Min.	Typ.	Max.		
IDRM	Repetitive peak off-state current	T _j =125°C, V _{DRM} applied	—	—	1.0	mA	
VTM	On-state voltage	T _c =25°C, I _{TM} =1.5A, Instantaneous measurement	—	—	1.6	V	
VFGT I	Gate trigger voltage *2	T _j =25°C, V _D =6V, R _L =6Ω, R _G =330Ω	I	—	—	2.0	V
VRGT I			II	—	—	2.0	V
VRGT III			III	—	—	2.0	V
VFGT III			IV	—	—	2.0	V
IFGT I	Gate trigger current *2	T _j =25°C, V _D =6V, R _L =6Ω, R _G =330Ω	I	—	—	5	mA
IRGT I			II	—	—	5*5	mA
IRGT III			III	—	—	5*5	mA
IFGT III			IV	—	—	10	mA
VGD	Gate non-trigger voltage	T _j =125°C, V _D =1/2V _{DRM}	0.1	—	—	V	
Rth (j-c)	Thermal resistance	Junction to case *4	—	—	50	°C/W	
(dv/dt) _c	Critical-rate of rise of off-state commutating voltage		*3	—	—	V/μs	

*2. Measurement using the gate trigger characteristics measurement circuit.
 *3. The critical-rate of rise of the off-state commutating voltage is shown in the table below.
 *4. Case temperature is measured at the T₂ terminal 1.5mm away from the molded case.
 *5. High sensitivity (I_{GT}≤3mA) is also available. (IGT item ①)

Voltage class	V _{DRM} (V)	(dv/dt) _c		Test conditions	Commutating voltage and current waveforms (inductive load)
		Min.	Unit		
8	400	2	V/μs	1. Junction temperature T _j =125°C 2. Rate of decay of on-state commutating current (di/dt) _c =-0.5A/ms 3. Peak off-state voltage V _D =400V	

PERFORMANCE CURVES

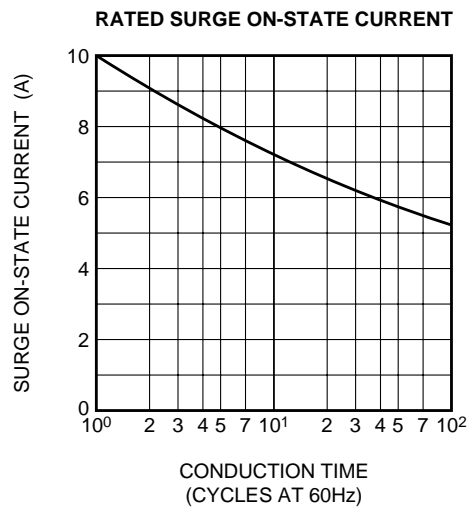
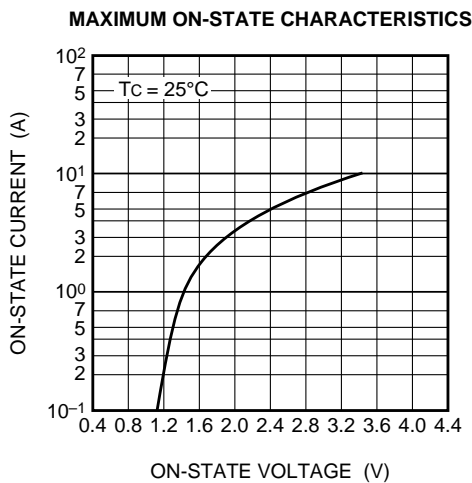

BCR1AM-8

LOW POWER USE
PLANAR PASSIVATION TYPE

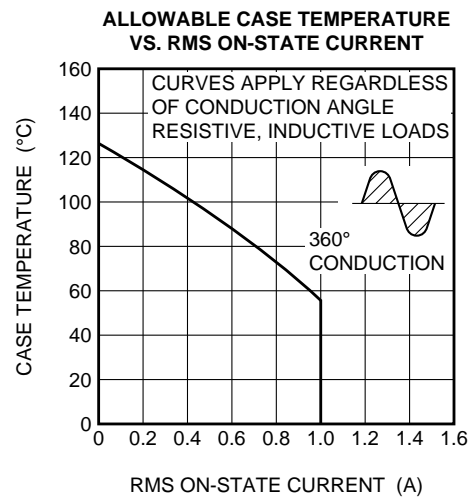
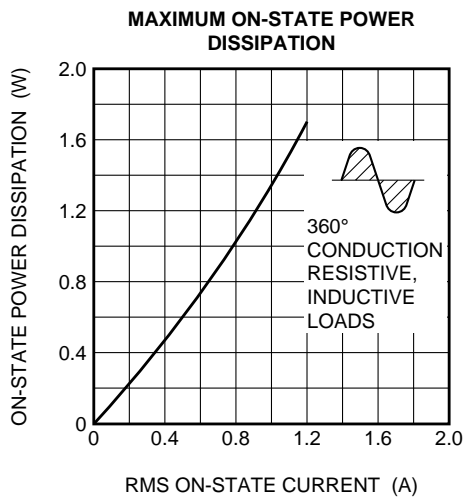
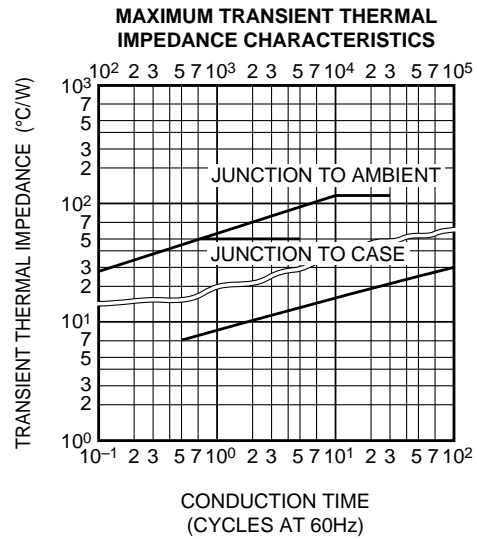
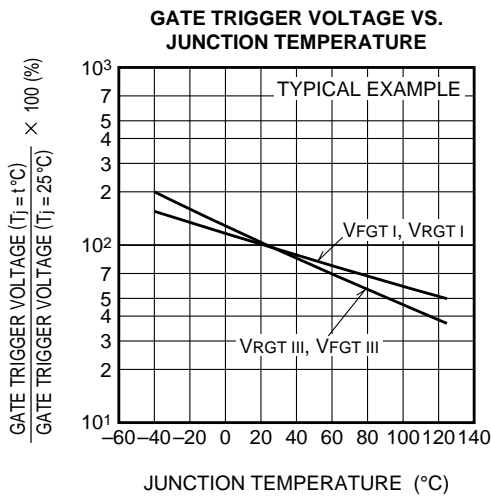
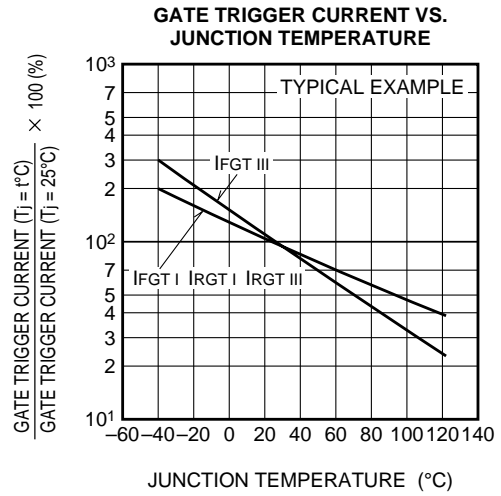
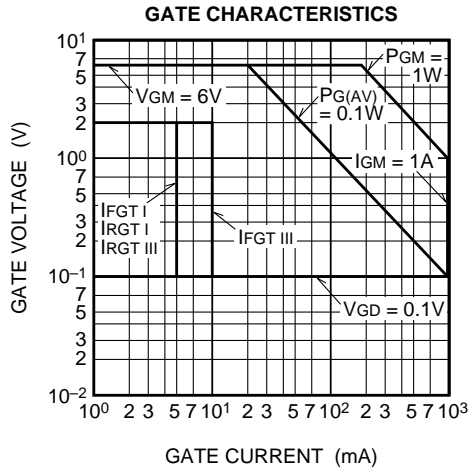

BCR1AM-8

LOW POWER USE
PLANAR PASSIVATION TYPE

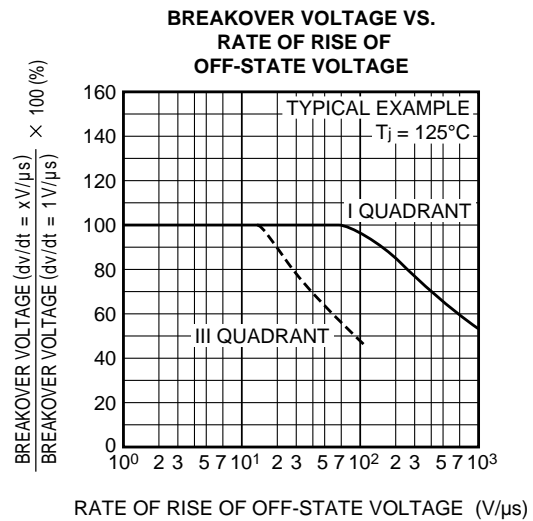
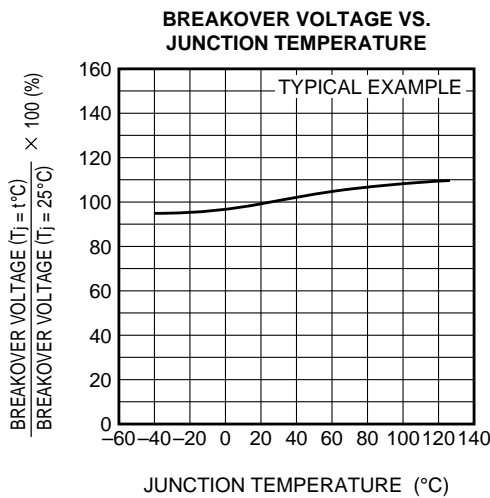
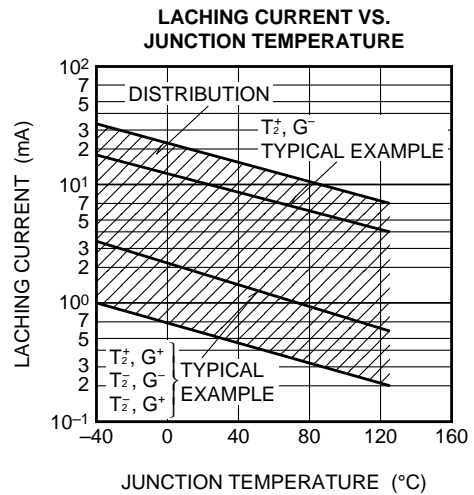
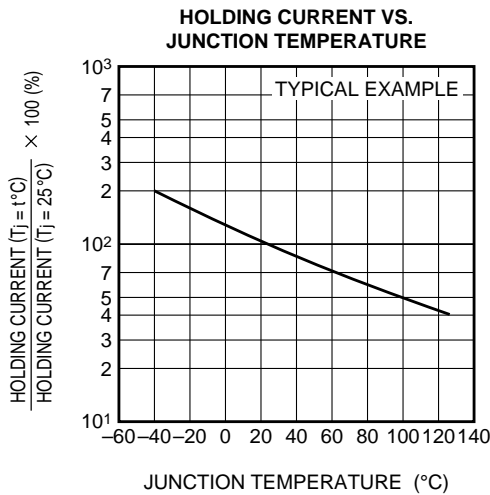
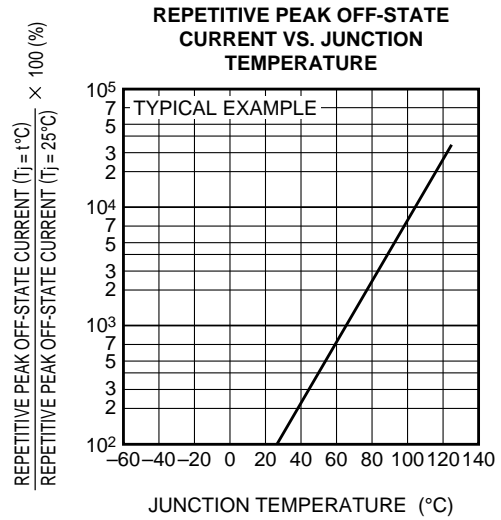
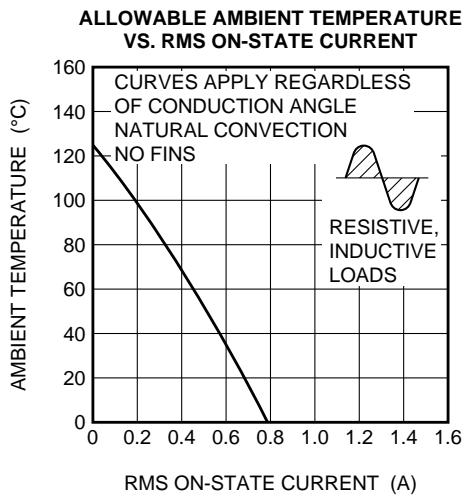

BCR1AM-8

LOW POWER USE
PLANAR PASSIVATION TYPE

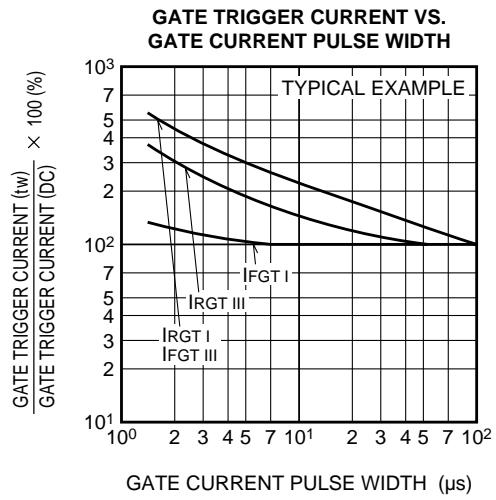
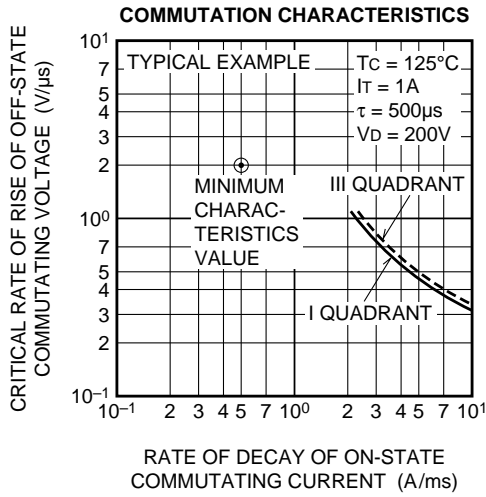

GATE TRIGGER CHARACTERISTICS TEST CIRCUITS

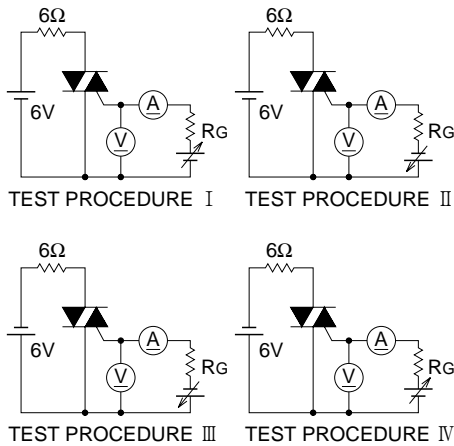

This datasheet has been download from:

www.datasheetcatalog.com

Datasheets for electronics components.