



Representative photograph, actual product appearance may vary.

Due to regional agency approval requirements, some products may not be available in your area. Please contact your regional Honeywell office regarding your product of choice.

SS441A

SS400 Series Unipolar Hall-Effect Digital Position Sensor; radial lead IC package

Features

- Digital current sinking output
- Quad-Hall design virtually eliminates mechanical stress effects
- Temperature compensated magnetics
- Operate/release points can be customized
- High output current capability
- Operate/release points symmetrical around zero gauss (bipolar/latch)
- Package material: Plaskon 3300H
- Surface mount version available: SS400-S (with cut and formed leads)

Description

SS400 Series position sensors have a thermally balanced integrated circuit over full temperature range. The negative compensation slope is optimized to match the negative temperature coefficient of lower cost magnets. Bipolar, latching and unipolar magnetics are available.

Band gap regulation provides extremely stable operation over 3.8 Vdc to 30 Vdc supply voltage range.

NOTE: Interruption of power to a latching device may cause the output to change state when power is restored. If a magnetic field of sufficient strength is present, the sensor output will be in the condition dictated by the magnetic field.



SS441A

SS400 Series Unipolar Hall-Effect Digital Position Sensor; radial lead IC package

Product Specifications	
Product Type	Hall-Effect Digital Position Sensor
Package Quantity/Type	Available in 1,000/Bag
Package Style	Radial Lead IC
Supply Voltage	3.8 Vdc to 30.0 Vdc
Output Type	Sink
Magnetic Actuation Type	Unipolar
Operating Temperature Range	-40 °C to 150 °C [-40 °F to 302 °F]
Output Voltage	0.4 Vdc max.
Switching Time Rise (10 % to 90 %)	0.05 µs typ., 1.5 µs max.
Switching Time Fall (90 % to 10 %)	0.15 µs typ., 1.5 µs max.
Availability	Global
Supply Current (max. @ 25 °C)	7.5 mA typ.
Output Current (max.)	20 mA
Operate Point @ 25 °C	8.5 mT [85 G] typ.
Release Point @ 25 °C	5.5 mT [55 G] typ.
Leakage Current max.	10 µA
Differential	3.0 mT [30 G] typ.
Series Name	SS400 Series

Honeywell

SS441A

SS400 Series Unipolar Hall-Effect Digital Position Sensor; radial lead IC package

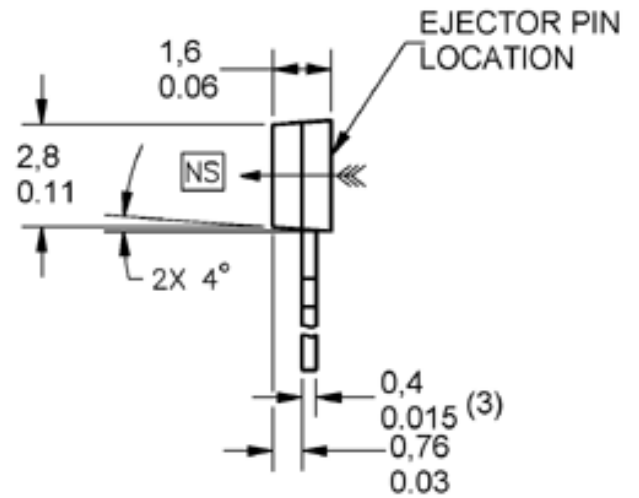
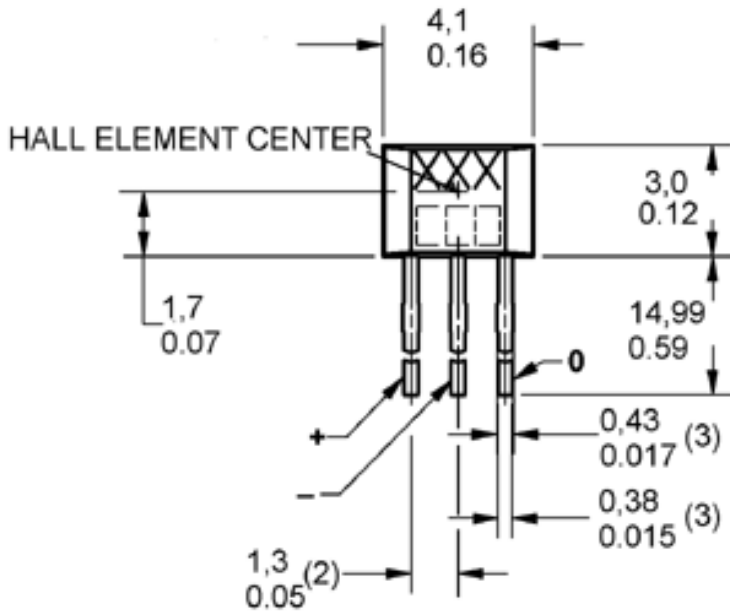
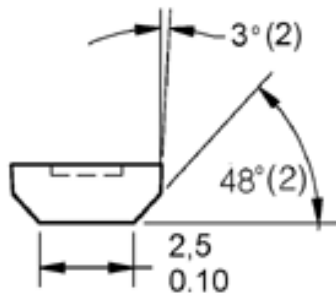

SURFACE MOUNT STYLE (-S)

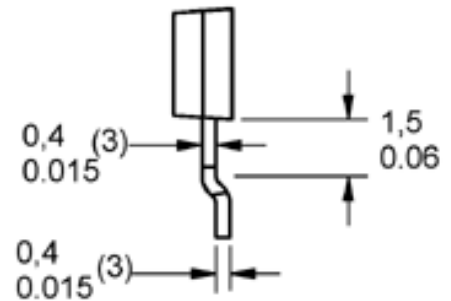
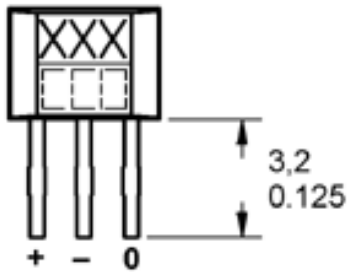

SS441A

SS400 Series Unipolar Hall-Effect Digital Position Sensor; radial lead IC package

SS441A

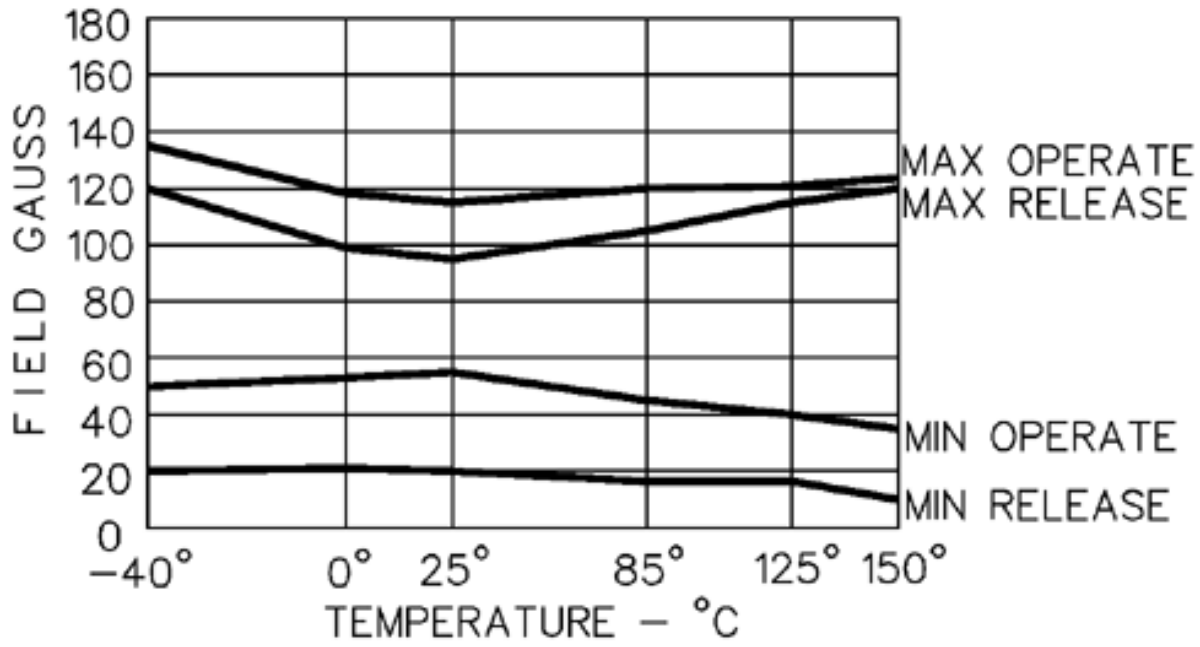

Honeywell

SS441A

SS400 Series Unipolar Hall-Effect Digital Position Sensor; radial lead IC package

Tape Style T2

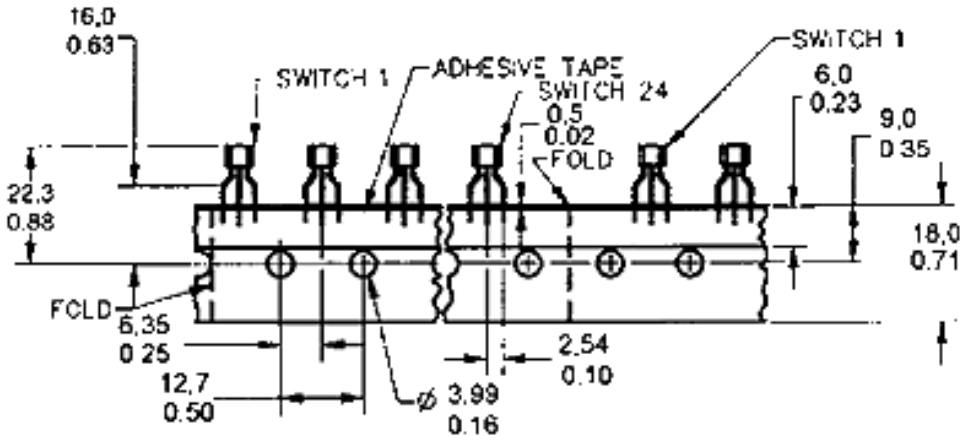

Tape Style T3

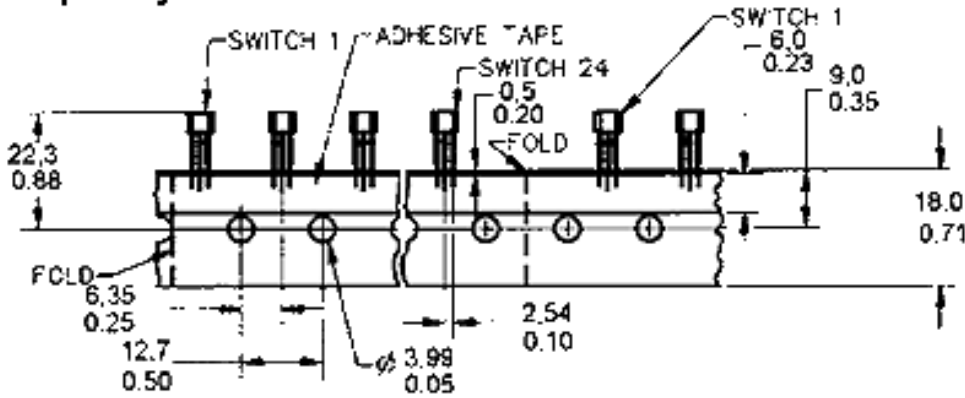

Tape Style SP & RP

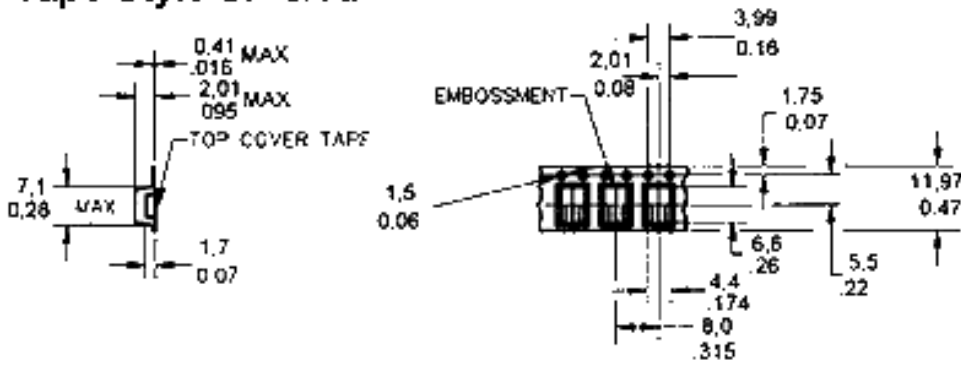

Direction of Feed from Reel

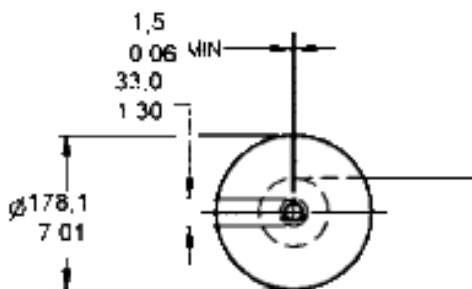

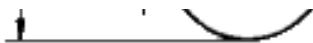

Honeywell

SS441A

SS400 Series Unipolar Hall-Effect Digital Position Sensor; radial lead IC package

WARNING

PERSONAL INJURY

DO NOT USE these products as safety or emergency stop devices, or in any other application where failure of the product could result in personal injury.

Failure to comply with these instructions could result in death or serious injury.

WARNING

MISUSE OF DOCUMENTATION

- The information presented in this product sheet (or catalog) is for reference only. DO NOT USE this document as product installation information.
- Complete installation, operation and maintenance information is provided in the instructions supplied with each product.

Failure to comply with these instructions could result in death or serious injury.