

Applications

- High frequency DC-DC converters

V_{DSS}	R_{DS(on)} max	I_D
200V	0.082Ω	31A

Benefits

- Low Gate-to-Drain Charge to Reduce Switching Losses
- Fully Characterized Capacitance Including Effective C_{OSS} to Simplify Design, (See App. Note AN1001)
- Fully Characterized Avalanche Voltage and Current

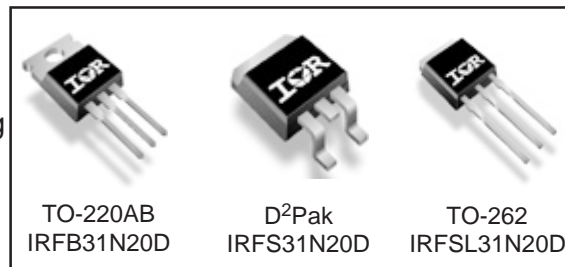

Absolute Maximum Ratings

	Parameter	Max.	Units
I _D @ T _C = 25°C	Continuous Drain Current, V _{GS} @ 10V	31	A
I _D @ T _C = 100°C	Continuous Drain Current, V _{GS} @ 10V	21	
I _{DM}	Pulsed Drain Current ①	124	
P _D @ T _A = 25°C	Power Dissipation ②	3.1	W
P _D @ T _C = 25°C	Power Dissipation	200	
	Linear Derating Factor	1.3	W/°C
V _{GS}	Gate-to-Source Voltage	± 30	V
dv/dt	Peak Diode Recovery dv/dt ③	2.1	V/ns
T _J	Operating Junction and	-55 to + 175	°C
T _{STG}	Storage Temperature Range		
	Soldering Temperature, for 10 seconds	300 (1.6mm from case)	
	Mounting torque, 6-32 or M3 screw④	10 lbf•in (1.1N•m)	

Typical SMPS Topologies

- Telecom 48V Input Forward Converters

Notes ① through ④ are on page 11
 www.irf.com

IRFB/IRFS/IRFSL31N20D

International
IR Rectifier

Static @ $T_J = 25^\circ\text{C}$ (unless otherwise specified)

	Parameter	Min.	Typ.	Max.	Units	Conditions
$V_{(BR)DSS}$	Drain-to-Source Breakdown Voltage	200	—	—	V	$V_{GS} = 0V, I_D = 250\mu A$
$\Delta V_{(BR)DSS}/\Delta T_J$	Breakdown Voltage Temp. Coefficient	—	0.25	—	V/°C	Reference to $25^\circ\text{C}, I_D = 1\text{mA}$
$R_{DS(on)}$	Static Drain-to-Source On-Resistance	—	—	0.082	Ω	$V_{GS} = 10V, I_D = 18A$ ④
$V_{GS(th)}$	Gate Threshold Voltage	3.0	—	5.5	V	$V_{DS} = V_{GS}, I_D = 250\mu A$
I_{DSS}	Drain-to-Source Leakage Current	—	—	25	μA	$V_{DS} = 200V, V_{GS} = 0V$
		—	—	250		$V_{DS} = 160V, V_{GS} = 0V, T_J = 150^\circ\text{C}$
I_{GSS}	Gate-to-Source Forward Leakage	—	—	100	nA	$V_{GS} = 30V$
	Gate-to-Source Reverse Leakage	—	—	-100		$V_{GS} = -30V$

Dynamic @ $T_J = 25^\circ\text{C}$ (unless otherwise specified)

	Parameter	Min.	Typ.	Max.	Units	Conditions
g_{fs}	Forward Transconductance	17	—	—	S	$V_{DS} = 50V, I_D = 18A$
Q_g	Total Gate Charge	—	70	110	nC	$I_D = 18A$
Q_{gs}	Gate-to-Source Charge	—	18	27		$V_{DS} = 160V$
Q_{gd}	Gate-to-Drain ("Miller") Charge	—	33	49		$V_{GS} = 10V, \text{④}$
$t_{d(on)}$	Turn-On Delay Time	—	16	—	ns	$V_{DD} = 100V$
t_r	Rise Time	—	38	—		$I_D = 18A$
$t_{d(off)}$	Turn-Off Delay Time	—	26	—		$R_G = 2.5\Omega$
t_f	Fall Time	—	10	—		$R_D = 5.4\Omega$ ④
C_{iss}	Input Capacitance	—	2370	—	pF	$V_{GS} = 0V$
C_{oss}	Output Capacitance	—	390	—		$V_{DS} = 25V$
C_{rss}	Reverse Transfer Capacitance	—	78	—		$f = 1.0\text{MHz}$
C_{oss}	Output Capacitance	—	2860	—		$V_{GS} = 0V, V_{DS} = 1.0V, f = 1.0\text{MHz}$
C_{oss}	Output Capacitance	—	150	—		$V_{GS} = 0V, V_{DS} = 160V, f = 1.0\text{MHz}$
$C_{oss \text{ eff.}}$	Effective Output Capacitance	—	170	—		$V_{GS} = 0V, V_{DS} = 0V \text{ to } 160V$ ⑤

Avalanche Characteristics

	Parameter	Typ.	Max.	Units
E_{AS}	Single Pulse Avalanche Energy②	—	420	mJ
I_{AR}	Avalanche Current①	—	18	A
E_{AR}	Repetitive Avalanche Energy①	—	20	mJ

Thermal Resistance

	Parameter	Typ.	Max.	Units
$R_{\theta JC}$	Junction-to-Case	—	0.75	°C/W
$R_{\theta CS}$	Case-to-Sink, Flat, Greased Surface ⑥	0.50	—	
$R_{\theta JA}$	Junction-to-Ambient⑥	—	62	
$R_{\theta JA}$	Junction-to-Ambient⑦	—	40	

Diode Characteristics

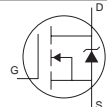
	Parameter	Min.	Typ.	Max.	Units	Conditions
I_S	Continuous Source Current (Body Diode)	—	—	31	A	MOSFET symbol showing the integral reverse p-n junction diode. 
I_{SM}	Pulsed Source Current (Body Diode) ①	—	—	124		
V_{SD}	Diode Forward Voltage	—	—	1.3	V	$T_J = 25^\circ\text{C}, I_S = 18A, V_{GS} = 0V$ ④
t_{rr}	Reverse Recovery Time	—	200	300	ns	$T_J = 25^\circ\text{C}, I_F = 18A$
Q_{rr}	Reverse Recovery Charge	—	1.7	2.6	μC	$di/dt = 100A/\mu s$ ④
t_{on}	Forward Turn-On Time	Intrinsic turn-on time is negligible (turn-on is dominated by $L_S + L_D$)				

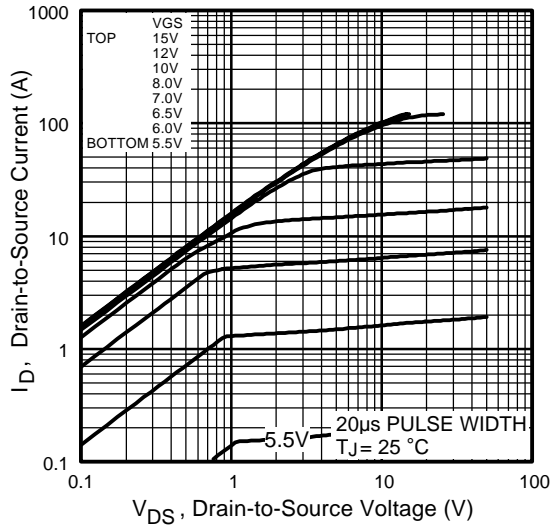

Fig 1. Typical Output Characteristics

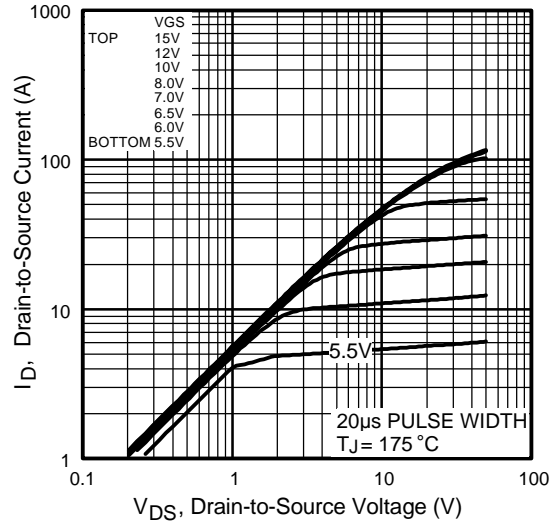

Fig 2. Typical Output Characteristics

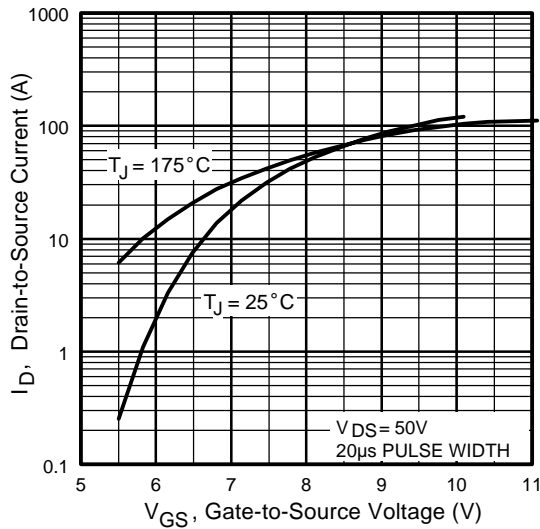

Fig 3. Typical Transfer Characteristics

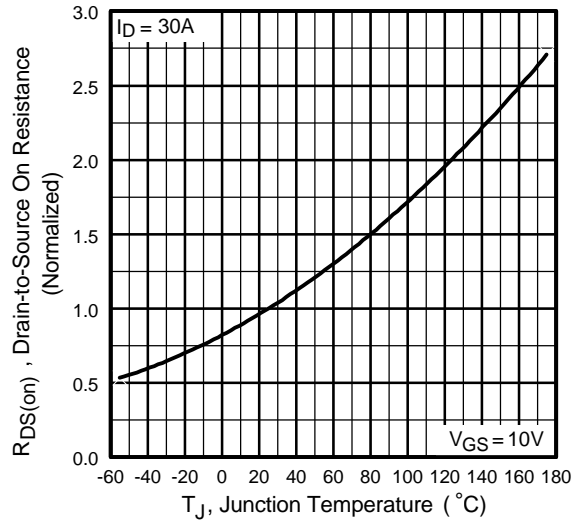

Fig 4. Normalized On-Resistance Vs. Temperature

IRFB/IRFS/IRFSL31N20D

International
IR Rectifier

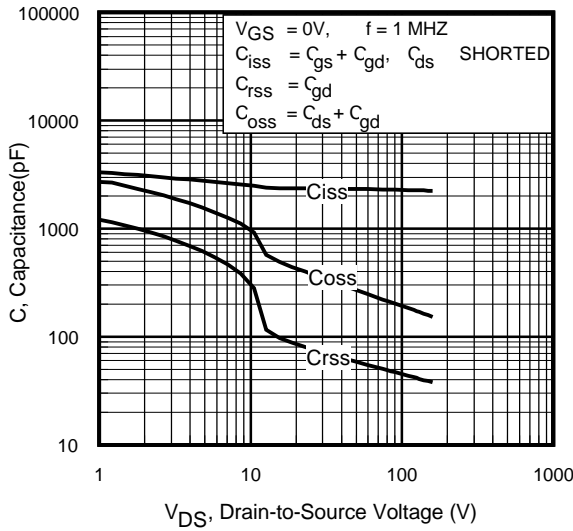

Fig 5. Typical Capacitance Vs. Drain-to-Source Voltage

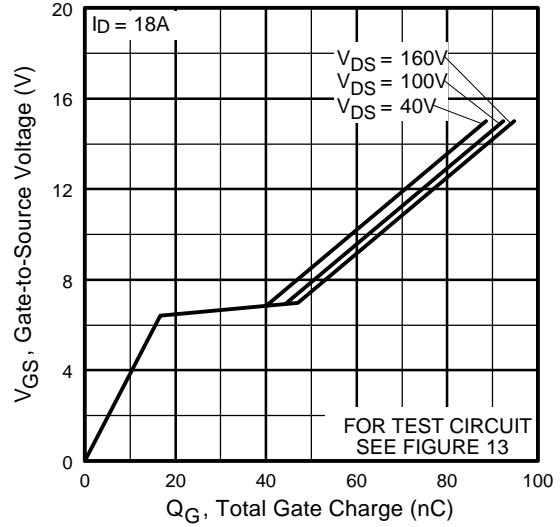

Fig 6. Typical Gate Charge Vs. Gate-to-Source Voltage

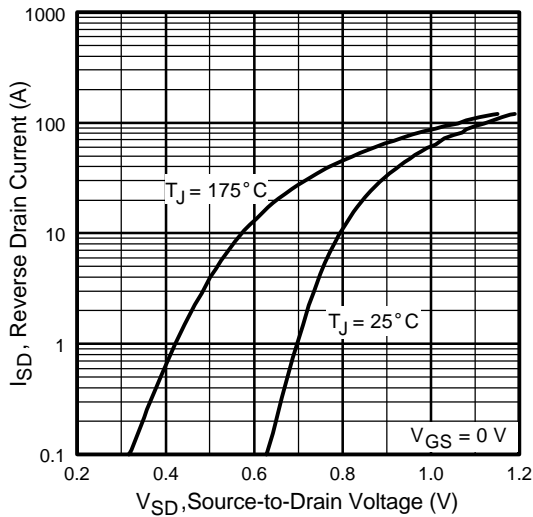

Fig 7. Typical Source-Drain Diode Forward Voltage

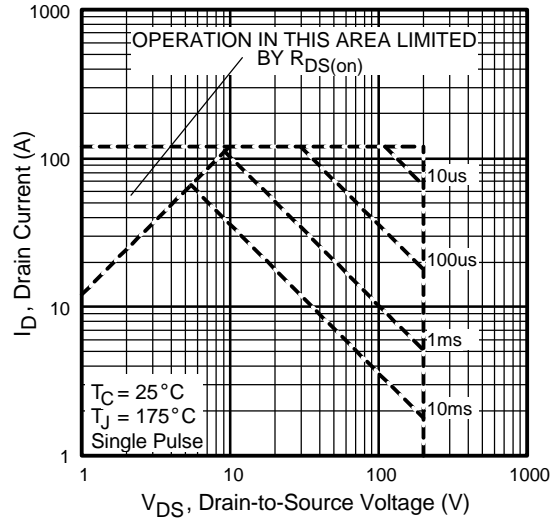

Fig 8. Maximum Safe Operating Area

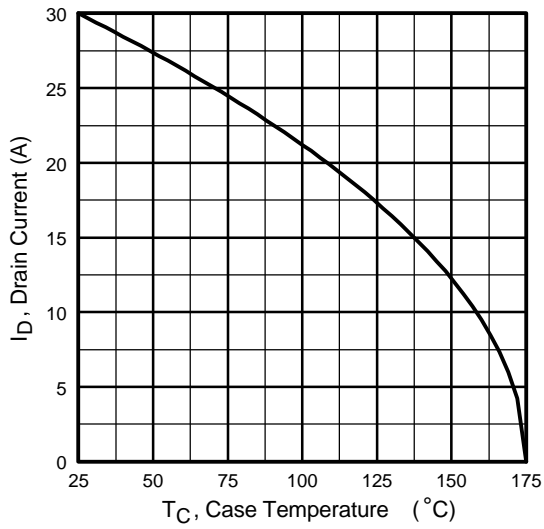

Fig 9. Maximum Drain Current Vs. Case Temperature

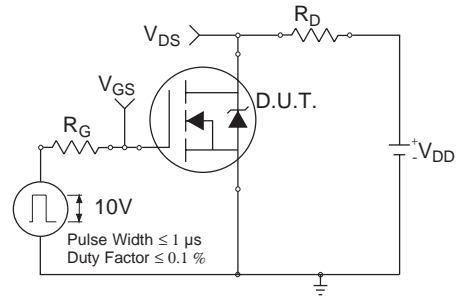

Fig 10a. Switching Time Test Circuit

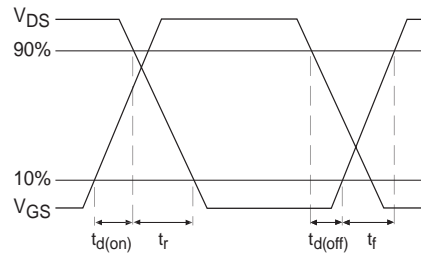

Fig 10b. Switching Time Waveforms

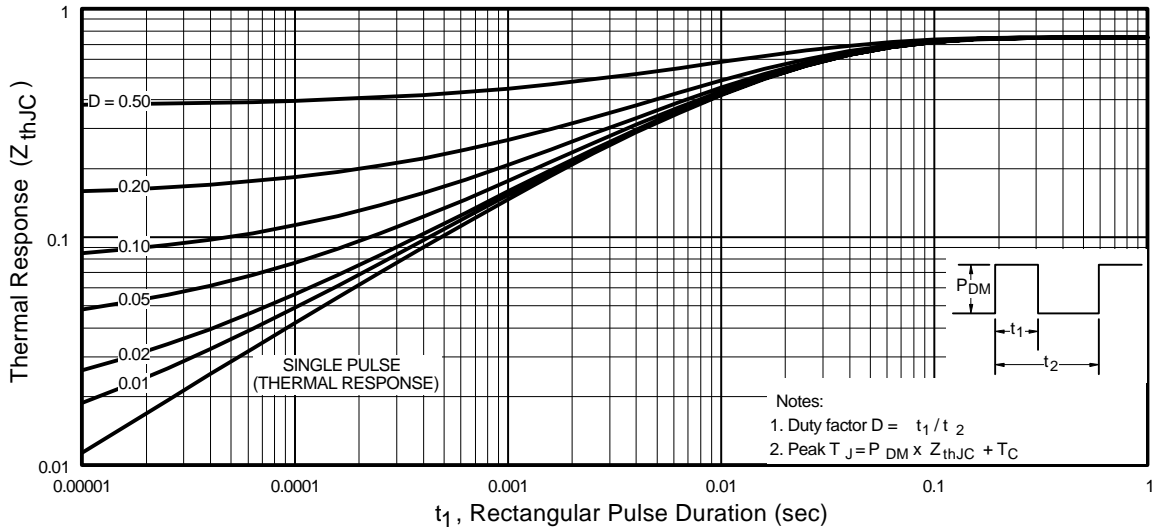

Fig 11. Maximum Effective Transient Thermal Impedance, Junction-to-Case

IRFB/IRFS/IRFSL31N20D

International
IR Rectifier

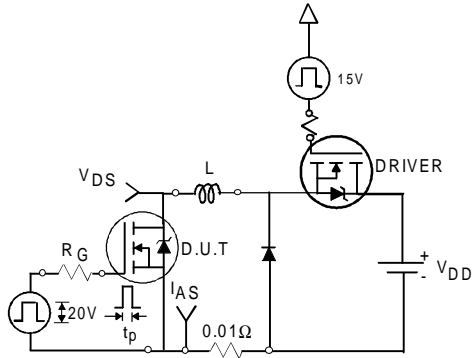

Fig 12a. Unclamped Inductive Test Circuit

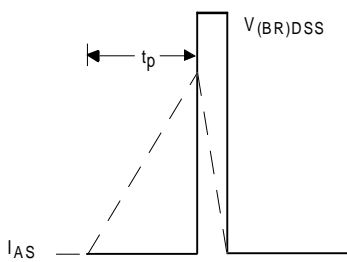

Fig 12b. Unclamped Inductive Waveforms

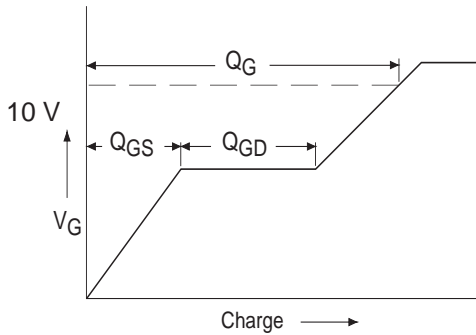

Fig 13a. Basic Gate Charge Waveform

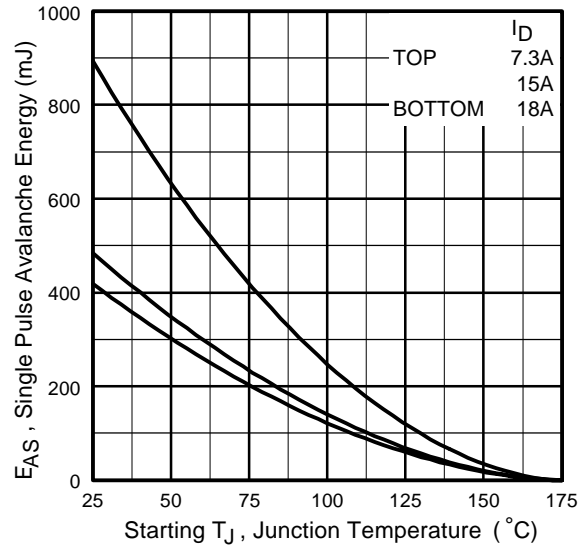

Fig 12c. Maximum Avalanche Energy Vs. Drain Current

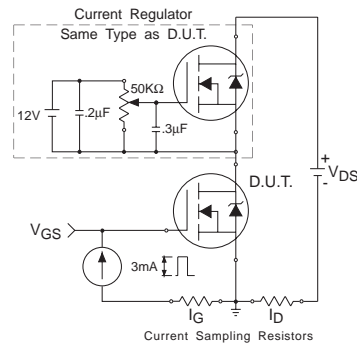
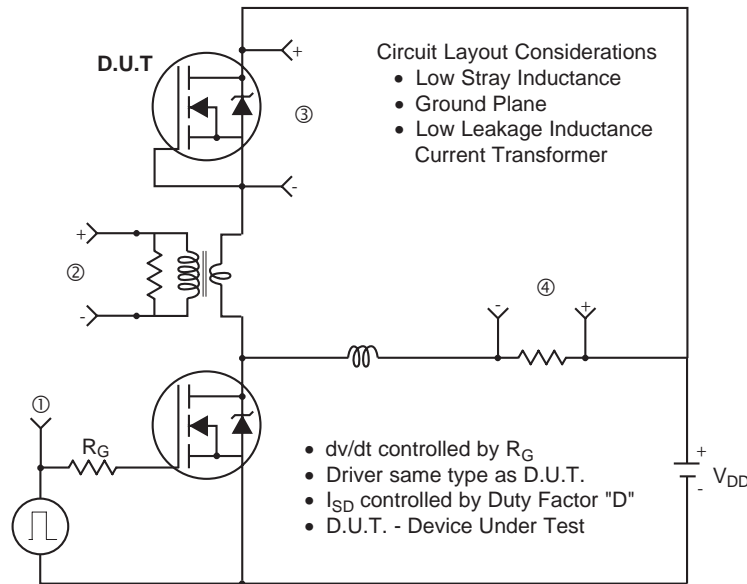

Fig 13b. Gate Charge Test Circuit

Peak Diode Recovery dv/dt Test Circuit



* $V_{GS} = 5V$ for Logic Level Devices

Fig 14. For N-channel HEXFET[®] Power MOSFETs

IRFB/IRFS/IRFSL31N20D



TO-220AB Package Outline

Dimensions are shown in millimeters (inches)

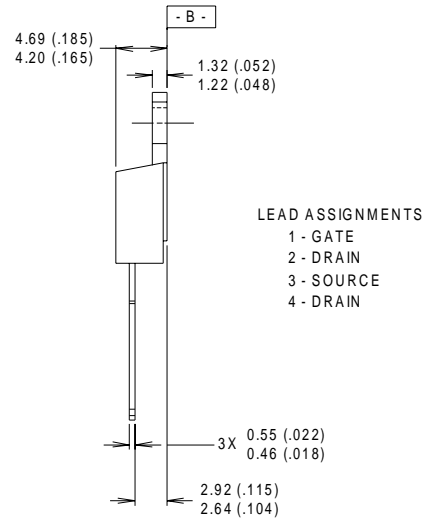
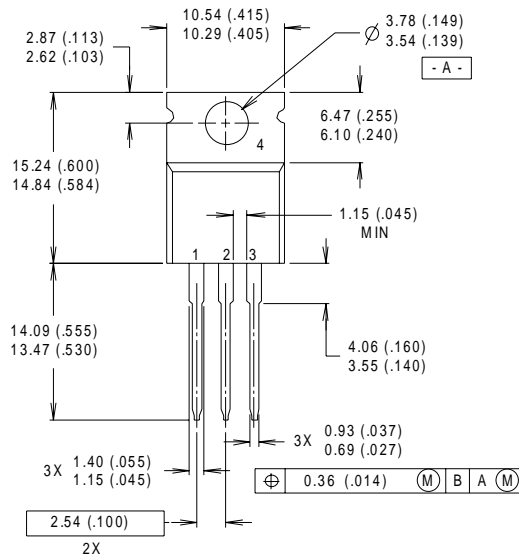

NOTES:

- 1 DIMENSIONING & TOLERANCING PER ANSI Y14.5M, 1982.
- 2 CONTROLLING DIMENSION : INCH

- 3 OUTLINE CONFORMS TO JEDEC OUTLINE TO-220AB.
- 4 HEATSINK & LEAD MEASUREMENTS DO NOT INCLUDE BURRS.

TO-220AB Part Marking Information

EXAMPLE : THIS IS AN IRF1010
WITH ASSEMBLY
LOT CODE 9B1M

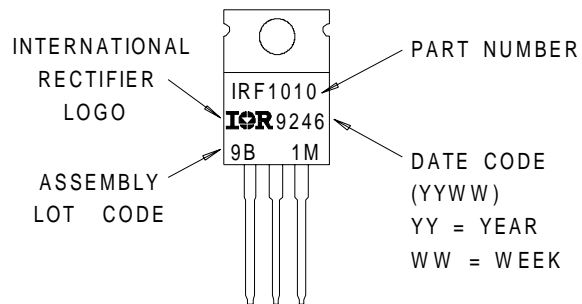

D²Pak Package Outline

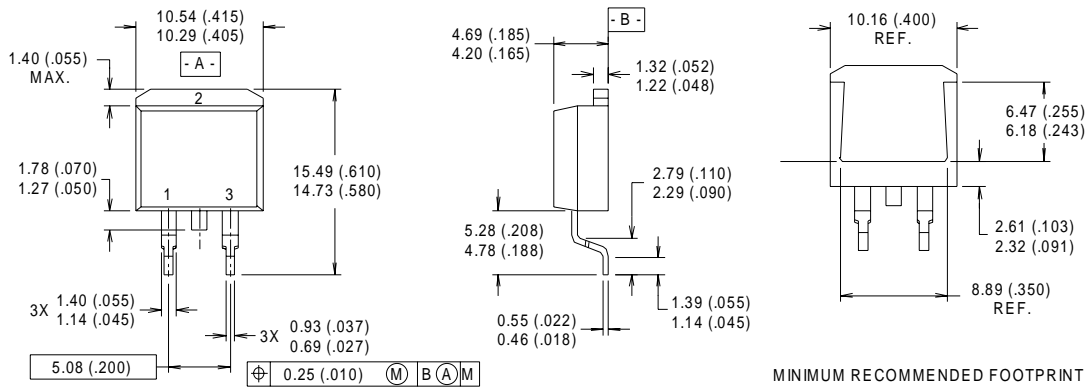

NOTES:

- 1 DIMENSIONS AFTER SOLDER DIP.
- 2 DIMENSIONING & TOLERANCING PER ANSI Y14.5M, 1982.
- 3 CONTROLLING DIMENSION : INCH.
- 4 HEATSINK & LEAD DIMENSIONS DO NOT INCLUDE BURRS.

LEAD ASSIGNMENTS

- 1 - GATE
- 2 - DRAIN
- 3 - SOURCE

D²Pak Part Marking Information

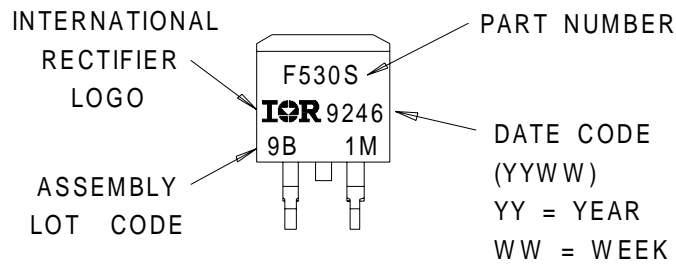

IRFB/IRFS/IRFSL31N20D



TO-262 Package Outline

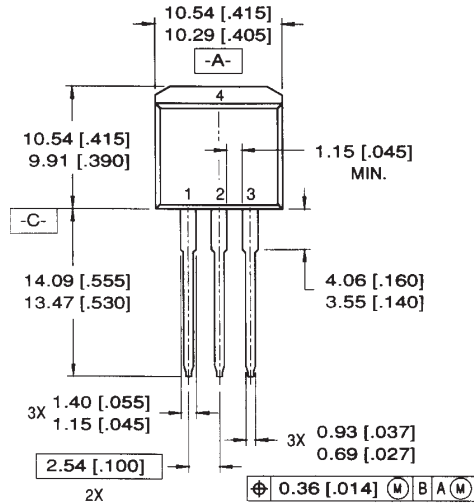

LEAD ASSIGNMENTS

- | | |
|-----------|------------|
| 1 = GATE | 3 = SOURCE |
| 2 = DRAIN | 4 = DRAIN |

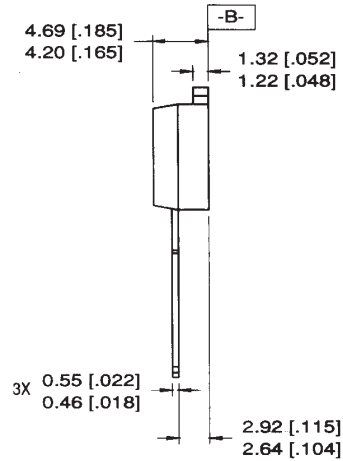

NOTES:

1. DIMENSIONING & TOLERANCING PER ANSI Y14.5M-1982
2. CONTROLLING DIMENSION: INCH.
3. DIMENSIONS ARE SHOWN IN MILLIMETERS [INCHES].
4. HEATSINK & LEAD DIMENSIONS DO NOT INCLUDE BURRS.

TO-262 Part Marking Information

EXAMPLE: THIS IS AN IRL3103L
 LOT CODE 1789
 ASSEMBLED ON WW 19, 1997
 IN THE ASSEMBLY LINE "C"

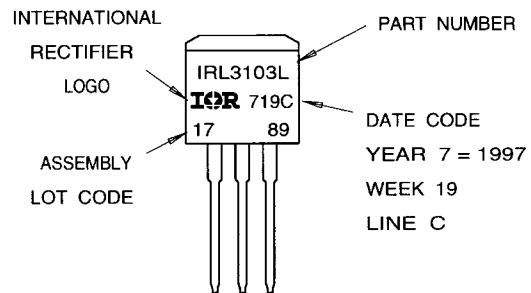

D²Pak Tape & Reel Information

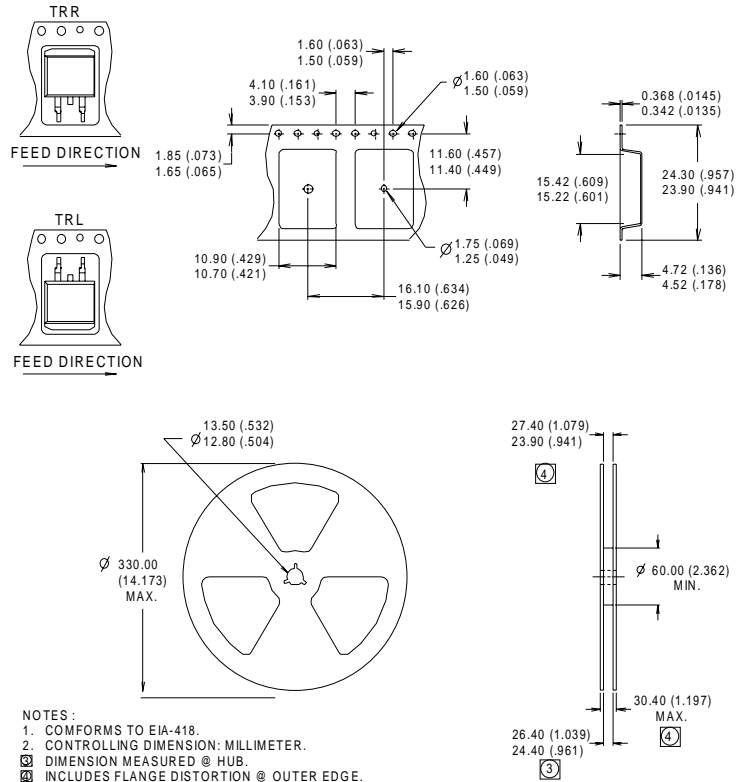

NOTES:
 1. CONFORMS TO EIA-418.
 2. CONTROLLING DIMENSION: MILLIMETER.
 ③ DIMENSION MEASURED @ HUB.
 ④ INCLUDES FLANGE DISTORTION @ OUTER EDGE.

Notes:

- ① Repetitive rating; pulse width limited by max. junction temperature.
- ② Starting $T_J = 25^\circ\text{C}$, $L = 3.8\text{mH}$
 $R_G = 25\Omega$, $I_{AS} = 18\text{A}$.
- ③ $I_{SD} \leq 18\text{A}$, $di/dt \leq 110\text{A}/\mu\text{s}$, $V_{DD} \leq V_{(BR)DSS}$,
 $T_J \leq 175^\circ\text{C}$
- ④ Pulse width $\leq 300\mu\text{s}$; duty cycle $\leq 2\%$.
- ⑤ C_{OSS} eff. is a fixed capacitance that gives the same charging time as C_{OSS} while V_{DS} is rising from 0 to 80% V_{DSS}
- ⑥ This is only applied to TO-220AB package
- ⑦ This is applied to D²Pak, when mounted on 1" square PCB (FR-4 or G-10 Material).
 For recommended footprint and soldering techniques refer to application note #AN-994.